

TRAFFIC SIGNAL MANUAL

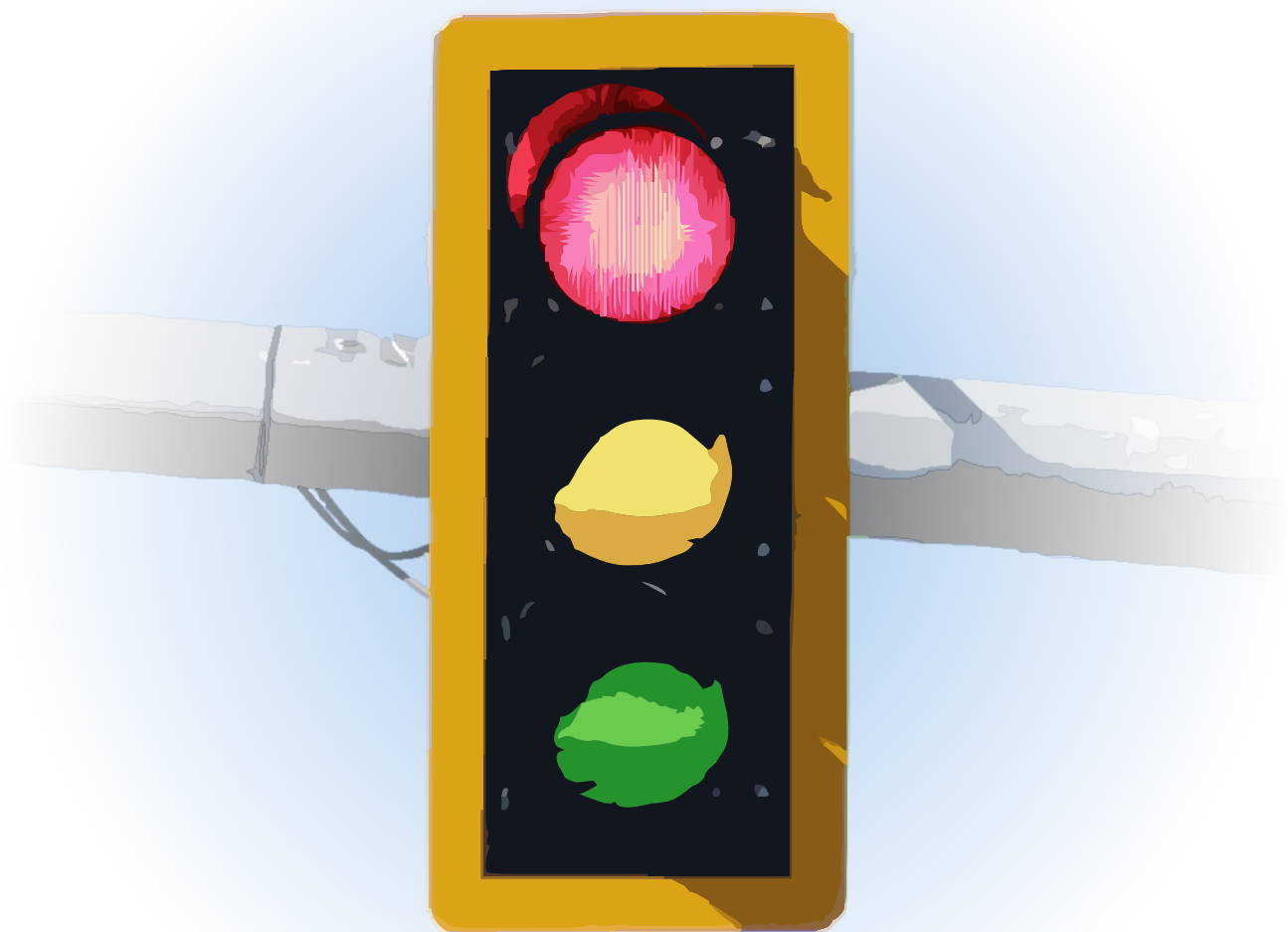

Table of Contents

1	INTRODUCTION	5
1.1	POLICIES.....	6
1.2	TRAFFIC STUDY CONSIDERATIONS.....	8
1.3	TRAFFIC SIGNAL DESIGN	9
1.4	SIGNAL REVIEW.....	11
1.5	SIGNAL ADJUSTMENT	12
2	TRAFFIC SIGNAL PERFORMANCE MEASURES.....	13
3	TRAFFIC SIGNAL OPERATIONS	14
3.1	SELECTION OF TRAFFIC SIGNAL OPERATIONS	14
3.1.1	Pre-timed (Fixed Time) Operation.....	14
3.1.2	Actuated Operation	14
3.1.3	Other Aspects	15
3.2	SIGNAL PHASING	16
3.2.1	Overview.....	16
3.2.2	Left Turn Phasing	16
3.2.3	Sequence of Left Turn Protection.....	20
3.2.4	LADOTD Phase Assignments.....	26
3.3	SIGNAL TIMING	31
3.3.1	Timing for Pre-timed Control	31
3.3.2	Timing for Actuated Control.....	34
3.3.3	Signal Timings and Flashing Yellow Arrows.....	41
3.4	PREEMPTION	43
3.4.1	Highway/Rail Signal Preemption Guidance	43
3.4.2	Bridge Preemption Guidance	50
3.5	ADVANCED TRAFFIC MANAGEMENT SYSTEM (ATMS).....	51
3.5.1	Signal Timings	51
3.5.2	Signal Alarms	51

4	SIGNAL EQUIPMENT AND SIGNS.....	53
4.1	GENERAL EQUIPMENT AND SIGN INFORMATION	53
4.2	VEHICLE DETECTORS.....	53
4.2.1	General	53
4.2.2	Detector Card/Channel Assignments	53
4.2.3	Detection Types.....	54
4.2.4	Detector Types.....	56
4.3	SIGNAL HEADS.....	57
4.3.1	Lens Size.....	57
4.3.2	Light Source	57
4.3.3	Back Plates.....	57
4.3.4	Number of Signal Faces	57
4.3.5	Positioning	57
4.3.6	Face Arrangement	57
4.3.7	Left Turn Signals	58
4.3.8	Right Turn Signals	59
4.3.9	Pedestrian Signal Indications.....	61
4.3.10	Visibilities and Shielding.....	61
4.4	TRAFFIC SIGNAL CONTROLLERS/ CABINETS/COMMUNICATION	62
4.4.1	Signal Controllers.....	62
4.4.2	Controller Cabinets.....	62
4.4.3	Communication	63
4.4.4	Coordination Without Communications	63
4.5	POWER SUPPLY	64
4.5.1	Location	64
4.5.2	Quantity.....	64
4.5.3	Luminaires	64
4.5.4	Conduit	64
4.6	SIGNAL SUPPORTS	65

4.6.1	Mast Arms.....	65
4.6.2	Strain Poles	70
4.7	SIGNAL WIRING	75
4.7.1	Signal Device Requirement.....	75
4.7.2	Mast Arm/Span Wire Runs	75
4.7.3	Detectors/Power/Interconnect Cable	75
4.7.4	Sizing Conduit	75
4.7.5	Signal Wiring Examples.....	75
4.8	CONDUIT	94
4.8.1	Material Type.....	94
4.8.2	Depth Installed (Underground)	94
4.8.3	Sizing.....	94
4.8.4	Jack and Boring	94
4.8.5	Spare Conduit	94
4.9	JUNCTION BOXES	95
4.9.1	Purpose.....	95
4.9.2	Type/Size/Use.....	95
4.9.3	Spacing.....	96
4.9.4	Material	96
4.10	SIGNS	96
4.10.1	Span Wire/Mast Arm (Overhead) Mounted.....	96
5	TRAFFIC SIGNAL INVENTORY & SIGNAL PLANS	118
5.1	Traffic Signal Inventory	118
5.1.1	When Required.....	118
5.1.2	Provided Formats	119
5.1.3	Traffic Signal Inventory.....	119
5.1.4	Traffic Signal Inventory Page Requirements	119
5.2	Traffic Signal Inventory Construction Format	134
5.2.1	Title Sheet.....	136

5.2.2	Summary of Estimated Quantities Sheets.....	137
5.2.3	Signal General Notes Sheet	139
5.2.4	Intersection Sequence and Phase Timing Parameters Sheet.....	140
5.2.5	Intersection Supplemental Sequence and Coordination Sheet	141
5.2.6	Intersection Diagram and Wiring Sheet	142
5.2.7	Intersection Count, Detection, and Quantity Sheet.....	143
5.2.8	Preemption Sheet.....	144
5.2.9	Signal Interconnect Sheet.....	145
5.2.10	Letter Size Intersection Plans	146
5.3	Additional Signal Plan Information	146
5.3.1	Construction Signals	146
6	Key Terms	147
7	Table of Figures.....	149
8	Appendix A	152

1 INTRODUCTION

The purpose of the Traffic Signal Manual is to help provide guidance in implementing and designing traffic signals. There are several key factors related to implementing a traffic signal. The most important factor is the following, as stated by the Manual on Uniform Traffic Control Devices (MUTCD):

“Traffic control signals are often considered a panacea for all traffic problems at intersections. This belief has led to traffic control signals being installed at many locations where they are not needed, adversely affecting the safety and efficiency of vehicular, bicycle, and pedestrian traffic.

Traffic control signals, even when justified by traffic and roadway conditions, can be ill-designed, ineffectively placed, improperly operated, or poorly maintained. Improper or unjustified traffic control signals can result in one or more of the following disadvantages:

- A. Excessive delay,
- B. Excessive disobedience of the signal indications,
- C. Increased use of less adequate routes as road users attempt to avoid the traffic control signals, and
- D. Significant increases in the frequency of collisions (especially rear-end collisions).”¹

There are several policies and procedures that must be followed in order to determine when a traffic signal is to be installed. These policies and procedures are the main purpose of this chapter, along with a basic explanation of the traffic signal process.

¹ MUTCD, 2009, Part 4, p. 435

1.1 POLICIES

The policies were created with the purpose of creating standards for the installation and use of a traffic signal.

Manual on Uniform Traffic Control Devices (MUTCD)

The MUTCD is a national manual that states the minimum requirements for traffic control. It should be noted that the MUTCD states the following:

“The Manual on Uniform Traffic Control Devices (MUTCD) is incorporated by reference in 23 Code of Federal Regulations (CFR), Part 655, Subpart F and shall be recognized as the national standard for all traffic control devices installed on any street, highway, bikeway, or private road open to public travel (see definition in Section 1A.13) in accordance with 23 U.S.C. 109(d) and 402(a). The policies and procedures of the Federal Highway Administration (FHWA) to obtain basic uniformity of traffic control devices shall be as described in 23 CFR 655, Subpart F.

In accordance with 23 CFR 655.603(a), for the purposes of applicability of the MUTCD:

- A. Toll roads under the jurisdiction of public agencies or authorities or public-private partnerships shall be considered to be public highways;
- B. Private roads open to public travel shall be as defined in Section 1A.13; and
- C. Parking areas, including the driving aisles within those parking areas, that are either publicly or privately owned shall not be considered to be “open to public travel” for purposes of MUTCD applicability.”²

The MUTCD 2009 Edition is the current version adopted by the Louisiana Department of Transportation and Development (LADOTD).

² MUTCD, 2009, Introduction, p. I-1

Engineering Directives and Standards Manual (EDSM)

The Engineering Directives and Standards Manual states LADOTD's requirements which are in addition to the MUTCD.

EDSM VI.3.1.2: Flashing Beacons and LED Flashing Signs

This policy is for all flashing beacons and LED flashing signs installed within LADOTD right-of-way. The Intersection Control Beacon, Warning Sign Beacon, Stop Beacon, or LED Flashing Signs cannot be installed until advance warning signs and/or oversized stop signs have been proven not to correct the problem.

EDSM VI.1.1.2: Intersection Control Evaluation (ICE) Requirements

This policy describes LADOTD's approach to an intergrated, systematic and performance based approach to traffic engineering as it relates to intersection control.

LADOTD's Access Connection Policy

The Access Connection Policy establishes uniform criteria regulating the location, design, and operation of new access connections, while balancing the needs and rights of property owners and roadway users. Traffic signal spacing for different roadway classifications are also defined in the Access Connection Policy.

LADOTD's Traffic Enforcement Systems Policy

The Traffic Enforcement Systems Policy provides guidance for the LADOTD in issuing permits to local governments for the installation of electronic traffic enforcement monitoring systems on state highway right-of-ways. Automated enforcement systems are designed to enhance safety and promote compliance with traffic laws.

LADOTD's Traffic Engineering Manual

The Traffic Engineering Manual is the compilation of LADOTD's traffic engineering policies such as the authorization for the 2009 MUTCD, the photo enforcement permit policy, use of signal ahead signs, removal of traffic signals, use of nonstandard traffic signal poles, removal of intersection control beacons, etc.

1.2 TRAFFIC STUDY CONSIDERATIONS

Certain studies are needed before plans for a new signal design can be created. These studies can vary depending on the situation. For information related to the studies or reports required please see the [Traffic Engineering Process and Report](#).

The following items should be considered and remembered during any study or data collection:

a. Signal Modifications

Existing signal modifications shall require the approval of the DTOE. A signal modification is everything except work which involves any one of the following for non-emergency purposes; the installation of a new controller and cabinet, rewiring the entire signal, installing all new poles or changing the layout of the signal.

b. Intersection Control Permits

An Intersection Control Permit is a request for either a new traffic signal, modification to an existing traffic signal, a flashing beacon, pedestrian signal, communication or other intersection control related devices. All permits shall be recommended for approval by the DTOE prior to LADOTD's Traffic Engineering Section review and approval.

c. Right Turn Volume Consideration

It should be determined if a right turn lane would affect the warrant prior to signal justification. If so, a right turn lane should be installed. Engineering judgment should be used to determine what, if any, portion of the right turn traffic is subtracted from the minor street traffic count when evaluating the count against the signal warrants. If right turns on an intersection approach are in a mixed lane containing through and right turning traffic, they could be included in the analysis. If the right turns are in their own lane and channelized away from the intersection, they could be excluded from the analysis. Engineering judgment should be applied in all cases and justified in the report.

d. Left Turn Lane

If a separate left turn lane is present on an approach, it may be counted as an approach lane if it carries approximately half the approach traffic volumes, and it has sufficient storage capacity to store the left turning traffic. If a left turn lane affects the justification of a signal, then a positive offset turn lane should be constructed prior to justification of a signal. Engineering judgment should be used for new and existing signals and justification shall be included in the report.

1.3 TRAFFIC SIGNAL DESIGN

Once the needed studies are completed and the traffic signal is justified and approved, the signal design can begin. The following are the steps for designing a traffic signal.

Traffic Signal Timings

In addition to the timings provided in the approved study, the following may be required by the District Traffic Operations Engineer (DTOE) and should use the same software as the intersection study:

- AM Weekend
- PM Weekend
- Off Peak
- Weekend function (ex: Church, Local show, etc.)
- Weekday function
- Emergency Evacuation Plans
- Special Event

Traffic Signal Inventory (TSI)

A TSI is a collection of all the information related to the traffic signal. This information includes an intersection layout, signal timings, detection zone settings, peak hour counts, preemption timings, and any additional information. A copy of the TSI is always kept in the signal cabinet, at the District office, and at Traffic Engineering and Services (Section 45). This document is used as an official record of the traffic signal. The following are the sheets included in a TSI (additional information related to the TSI Format can be found in Chapter 5 of this manual):

Signal Coordination Timings

This sheet is a form containing the timings for signal coordination. It is possible for there to be several coordination plans listed. These plans typically represent morning and evening peaks, but can include timings for evacuation, weekend peaks, sports events, etc. (Note: Coordinated timings are not always needed but this page should always be provided.)

Signal Phase Timing Parameters (Previously Signal Free Operation Timings)

This sheet contains signal timings needed for Free Operation; it also contains information used in coordination timing. Free Operation timings are used when coordination timings are either not programmed or not being used. (Note: Free operation timings are always needed.)

Signal Intersection Layout

This layout depicts the intersection along with its equipment locations, including the detection areas for any detection equipment used. This layout also shows intersection features such as lane widths, driveways, property, striping, signing, etc.

Signal Wiring Diagram

This diagram shows the location as well as the type of wiring and junction boxes needed for the traffic signal.

Signal Counts

This sheet is a record of the counts used for signal timing. It typically contains the morning and evening counts. You can also find the peak hour factor (PHF) for each period here. (Note: This page is required for all signals.)

Signal Preemption Timings

This sheet contains timings required for instances when a signal will have to be preempted. Such instances may include trains, police, ambulance, drawbridge, and more. (Note: This sheet is not needed for all signals.)

Signal Maintenance

This sheet is used to track any maintenance performed on the signal after construction such as timing adjustments, change in hardware, or inspections. (Note: This page is optional if Traffic Signal is on ATMS.now.)

1.4 SIGNAL REVIEW

During the signal design process reviews are required in order to ensure proper QA/QC. The reviews shall occur at a minimum of the plan percentages listed below and shall include all items from the previous submittal with comments addressed. The expected items for each plan percentage review are also show.

- **Road Design Project/Bridge Design Project**
 - 30% Final Plans
 - Proposed Hardware locations
 - Proposed New Signal Timings
 - 60% Final Plans
 - Proposed Signal wiring
 - List of Items for signal work
 - Response to previous comments
 - Special Foundation Designs (if required)
 - 95% Final Plans
 - Estimated Item quantities
 - Response to previous comments
- **Signal Design Project (Projects that contain only signal work)**
 - 98% Preliminary Plans
 - Proposed Hardware locations
 - Proposed New Signal Timings
 - 60% Final Plans
 - Proposed Signal wiring
 - List of Items for signal work
 - Response to previous comments
 - Special Foundation Designs (if required)
 - 95% Final Plans
 - Estimated Item quantities
 - Response to previous comments

Comments from these reviews are provided to the designer for responses/correction. Once all comments are addressed from all reviews the plans are complete and the Traffic Signal Standard Plans will be released.

Reviews for construction projects, shall be sent to the Project Manager, the DTOE, and LADOTD's Traffic Engineering Section for review. A signal design prepared by permit shall be sent to the DTOE, LADOTD's Traffic Engineering Management Administrator, and LADOTD's

Headquarters' Permit Section for review. Furthermore, all District Operation projects shall be reviewed by the DTOE.

1.5 SIGNAL ADJUSTMENT

After construction and/or signal timing input are complete, the signal will require signal timing inspections. The DTOE will need to be contacted to perform signal timing inspections. The DTOE's office will also need to be present at the time the traffic signal is turned on. The DTOE's inspection involves checking the timings based on how traffic is flowing. Adjustment to the traffic signal timings are performed as needed to make traffic flow as smoothly as possible. This inspection may also include a travel time study. This travel time study is used to show if the improvements matched the analysis. For more information related to equipment for field inspections, see LADOTD's Traffic Signal Standard Plans and the Standard Specifications for Roads and Bridges. (Note: Please be aware that any computer analysis gets signal timings close to what it needs to be, but field observations are always required to ensure peak performance of the traffic signal.)

2 TRAFFIC SIGNAL PERFORMANCE MEASURES

This Chapter is reserved for future LADOTD Traffic Signal Performance Measures information. For information related to this Chapter's previous content please see LADOTD's website for the [Traffic Engineering Process and Report](#).

3 TRAFFIC SIGNAL OPERATIONS

3.1 SELECTION OF TRAFFIC SIGNAL OPERATIONS

The following guidelines are given to aid in the selection of the proper type of signal operations for a given set of conditions at an intersection. Final approval for signal operations shall be provided by the District Traffic Operations Engineer (DTOE).

3.1.1 Pre-timed (Fixed Time) Operation

A pre-timed (fixed time) operation is the mode of operation in which a signal operates where the timing and phasing do not vary from cycle to cycle. Pre-timed control is best suited to intersections where traffic patterns are either relatively stable or predictable such that the variations in traffic that do occur can be accommodated by predetermined timing plans without contributing to unreasonable delays or congestion.³

3.1.2 Actuated Operation

Actuated traffic control signals differ from the pre-timed operation in that the phase interval duration may vary from cycle to cycle or some phases may be omitted during a cycle.

Actuated Control Provides Several Advantages:

- i. Maximum efficiency may be attained where traffic volumes fluctuate widely and irregularly and cannot be anticipated and programmed for with pre-timed control.
- ii. Where interruptions to main street flow must be minimized.
- iii. At intersections that have periods of light traffic activity, actuated control can provide continuous stop-and-go operation even in periods of light traffic without causing unnecessary delay to traffic on the major street.

³ Traffic Control Devices Handbook, 2001, p. 277

a. Semi-Actuated Control

- i. At least one, but not all, of the signal phases function on the basis of actuation.
- ii. Will usually provide maximum efficiency at an intersection of a major street and a minor street by interrupting the major street flow only when required for minor street vehicular or pedestrian traffic.
- iii. Generally preferable when actuated control is used in a coordinated system.

b. Fully Actuated Control

- i. All signal phases function with stop bar actuation.
- ii. Primarily used at the intersection of streets with approximately equal volumes, with sporadic and varying traffic distribution.⁴

c. Volume Density Control

- i. A signal that uses stop bar detection for the minor route phasing while using setback detection for the major route through phasing.
- ii. Primarily used at intersections with varying vehicle arrivals. The detection allows for dynamic changes of the major route's green times during free operation. The major route's green times dynamic changes will not occur during coordination.

3.1.3 Other Aspects

a. Signal Coordination

When intersection spacing and traffic speeds are favorable, it is possible to establish timing relationships between adjacent signals that provide for coordinated traffic flow along the corridor.

b. Signal Systems

When 2 or more signals operate in a synchronous manner, a signal system exists.⁵

⁴ Manual of Traffic Signal Design, 2nd ed., 2006, p. 33

⁵ Traffic Control Devices Handbook, 2001, p. 336

c. Hard Flash

A hard flash is an unplanned flashing signal state. All LADOTD traffic signals shall flash red on all approaches to minimize driver confusion.

d. Soft Flash

A soft flash is a planned flashing signal state. Traffic signals shall flash either all red or yellow on the major route and red on the minor route for a soft flash. An example of when a soft flash is used, would be for Hurricane Evacuation.

e. Start Up Flash

A start up flash is when a signal starts up from being dark. All LADOTD traffic signals shall flash red on all approaches to minimize driver confusion.

3.2 SIGNAL PHASING

3.2.1 Overview

A signal phase is the right-of-way, yellow change and red clearance intervals in a cycle that are assigned to an independent traffic movement or combination of movements.⁶ The required phases for a signal is determined based on the study for the intersection which shall include at a minimum crash history, capacity analysis, and geometry.

Although there are no limitations on the number of phases that can be utilized, they should be held to a minimum, especially in pre-timed controllers. More than three phases tend to increase cycle length and delay as they reduce the green time available to other phases. Increased phasing impairs intersection efficiency by increasing start-up delays, adding change intervals, increasing cycle lengths, and so forth. In determining the number of phases required at an intersection, the goals of safety and capacity may conflict.

3.2.2 Left Turn Phasing

The primary phasing issue are left-turns. In general, as left-turning volumes and opposing through volumes increase, a point is reached where left-turning traffic cannot find safe and adequate gaps.⁷ When designing a signal and the operational efficiency is lacking due to the high demand of left turners conflicting with the side street or through traffic, the designer should consider an alternative phasing scheme. This phasing scheme would limit access at the signal but still provide users safe and efficient access at another location. The designer should also use AutoTurn to determine the design vehicle's path and to ensure a proper design.

⁶ MUTCD, 2009, Part 1, p.20, Section 1A.13 Par. 206

⁷ Manual of Traffic Signal Design, 2006, p.29

a. Types of Left Turn Protection

Left turn phasing should not be an option without an adequate left turn lane. If a study shows a left turn lane is needed at an existing signalized intersection, then this should be planned for in future construction. There are two basic types of left turn protection: protected only left turns/U-turns and protected/permitted left turns/U-turns. The guidelines for choosing each option are defined as follows.

i. Protected Only Left Turns/U-Turns

This type of left turn/U-turn operation allows left turns/U-turns to be made only when a left turn green arrow is displayed. A protected left turn/U-turn shall be used when any of the following conditions exist:

1. **Limited left turn sight distance** – The view of opposing through and opposing right turn traffic is restricted. If the vehicle turning left has inadequate sight distance as shown in Figure 3-2, then there must be a protected only left turn phasing. Positive offset lefts can correct this issue.
2. **Excessive street width** – Left turning traffic must cross three or more lanes and the speed of the opposing traffic is 45 MPH or greater.
3. **Inadequate Geometry** – At intersections where there is inadequate room for opposing left turn movements on the same street to move simultaneously without conflicting or crossing.
4. **Left turn crashes** – Protected only left turn phasing should be considered on an approach if the number of left turn crashes has been greater than 3 in a 12 month period.
5. **Dual left turns** – If there are 2 or more left turn lanes on an approach then there must be a protected only left turn phase.

ii. Protected/Permitted Left Turns/U-Turns

The Protected/Permitted operation allows protected left turns/U-turns to be made on the left turn green arrow, while allowing permitted left turns on a circular green signal indication or the flashing yellow arrow indication. For permitted left turns the indication type used is determined by having a designated left turn lane. For locations with a designated left turn lane a flashing yellow arrow indication shall be used. In Table 3-1 – Protected/Permitted Left Turn/U-Turn Heads example signal heads are provided. See Chapter 4 Section C.7 Left Turn Signals for additional information related to left turn signal head/hardware.





Protected/Permitted Left Turn/U-Turn Heads	
Shared Lane 	Designated Lane 
	 (Permitted Only)

Figure 3-1– Protected/Permitted Left Turn/U-Turn Heads

See Sections f and g of this Chapter for information on the “yellow trap.” Protected/Permitted left turns/U-turns may be considered when none of the protected only conditions as stated in Section 3.2.2 have been met. Due to the increased exposure of left turning and opposing through vehicles that conflict with each other during the permitted phase, the safety benefits are not as high as with protected only but the delay is usually less.⁸

Sight distance should be taken into account when determining if protected/permitted left turns/U-turns should be used. Figure 3-2 – Intersection Sight Distance – Left Turn from Major Road provides a reference to possible sight distance. It is a designer’s responsibility to look at possible sight distance concerns as it relates to the traffic signal. Offsetting the left turn lanes can improve sight distance and safety for the left turning vehicles.

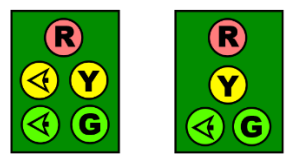
⁸ NCHRP Report 500, Volume 12, 2004, p. V-7

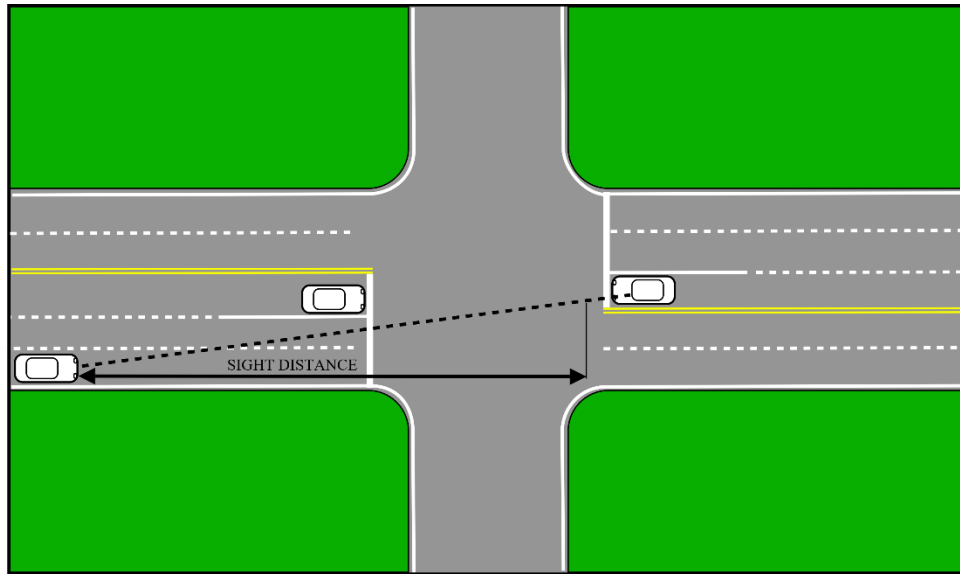

DESIGN SPEED (MPH)	LEFT TURN SIGHT DISTANCE (FT) FOR PASSENGER CARS BASED ON NUMBER OF OPPOSING LANES		
	1 - LANE	2 - LANE	3 - LANE
15	125	135	145
20	165	180	195
25	205	225	240
30	245	265	290
35	285	310	335
40	325	355	385
45	365	400	430
50	405	445	480
55	445	490	530
60	490	530	575

This information is for Center Left Turn Lanes with no median.
 The above figure should be adjusted for wide medians or offset turn lanes.
 (See AASHTO Green Book - Case F - p.9-56)

Design vehicle	Time gap (tg) (seconds) at speed of major road
Passenger car	5.5
Single-unit truck	6.5
Combination truck	7.5

Adjustment for multilane highways:

For left-turning vehicles that cross more than one opposing lane, add 0.5 seconds for passenger cars and 0.7 seconds for trucks for each additional lane to be crossed.

Figure 3-2 - Intersection Sight Distance - Left Turn from Major Road

3.2.3 Sequence of Left Turn Protection

Once the type of left turn protection is determined, it must then be decided where to sequence the left turn phase in the signal cycle. Additionally, if there is more than one left turn phase to be added, it must also be decided how they will sequence in relation to one another. The following guidelines are provided for making decisions for the sequencing of left turns.

a. Leading Left Turn

This defines a left turn signal phase that proceeds the through green signal phase on a particular street (see Figure 3-3 - Leading Left Turn with Protected/Permitted Operations). It should be used in the following circumstances.

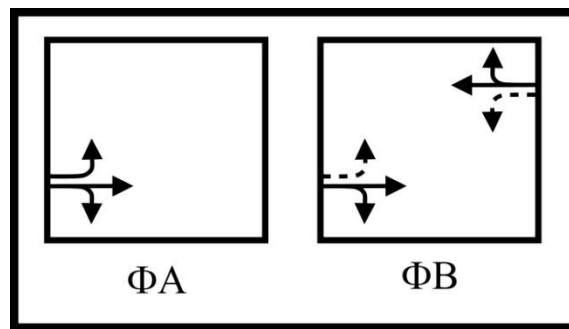

Figure 3-3 - Leading Left Turn with Protected/Permitted Operations

- **Signal Coordination** - Where a time-space diagram indicates that a leading left turn signal phase will increase the arterial green bandwidth and improve the signal progression.
- **Minimizing Conflicts** - To minimize conflicts between left turn and opposing through vehicles by clearing the left turns through the intersection first.⁹
- **Maximize Efficiency** - Left turning motorists tend to react quicker to a leading left turn than to a lagging left turn.¹⁰

⁹ Traffic Engineering Handbook, 6th ed., 2009, p. 414

¹⁰ Traffic Engineering Handbook, 6th ed., 2009, p. 414

b. Lagging Left Turn

This defines a left turn signal phase that comes at the end of the through green signal phase (see Figure 3-4 Lagging Left Turn with Protected Operations). It may be used in the following circumstances.

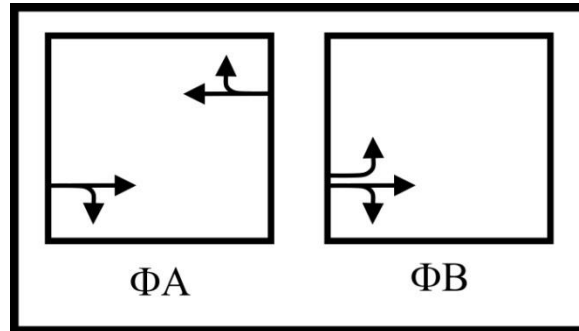

Figure 3-4 Lagging Left Turn with Protected Operations

- **Minimize Through Delay** - Where offset left turn lanes exist, it minimizes the use and length of the protected left turn phase by allowing left turns to be made during the preceding through green phase when adequate gaps occur in opposing traffic.¹¹
- **Signal Coordination** - Where a time-space diagram indicates that a lagging left turn signal phase will increase the arterial green bandwidth and improve signal progression.

¹¹ Traffic Engineering Handbook, 6th ed., 2009, p. 414

c. Lead/Lag Left Turns

This is the combination where both a leading and lagging left turn signal phase is provided on the same street. (See Figure 3-5 Lead-Lag Left Turns with Protected Operations) If using protected/permitted left turns, a “yellow trap” may occur (See Section B.3-f of this Chapter). Lead/lag left turns may be used in the following circumstances:

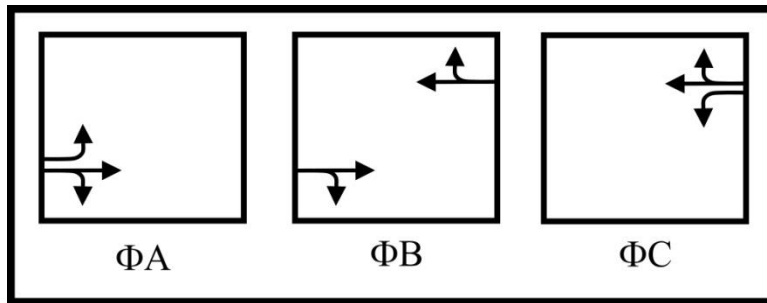

Figure 3-5 Lead-Lag Left Turns with Protected Operations

- **Signal coordination** - Where a time-space diagram indicates that a lead/lag left turn combination in the proper direction will increase the arterial green bandwidth and improve signal progression and a “yellow trap” can be programmed out if permitted turns are allowed.
- **Unequal left turn volumes** - To allow for the separate timing of each protected only left turn phase when using a pre-timed controller.
- **Inadequate Intersection Geometry** - At intersections where there is inadequate room for opposing left turn movements on the same street to move simultaneously without conflicting or crossing. Protected only left turns must be used.

d. Simultaneous Left Turns (Dual Lead or Dual Lag)

This defines the situation where the two opposing left turn movements on the same street are programmed to occur simultaneously (See Figure 3-6 Simultaneous Leading Left Turns with Protected/Permitted Operations). Before running simultaneous left turns, the turning radii shall be checked to ensure that the left turns can safely be run together. These left turns can either lead or lag the through phase. It may be used in the following circumstances.

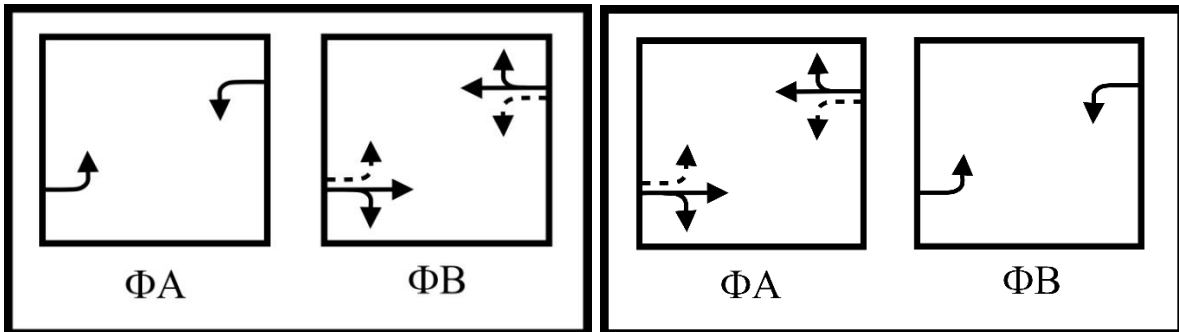

Figure 3-6 Simultaneous Leading Left Turns with Protected/Permitted Operations

- **Adequate intersection geometry** - The intersection geometry is adequate to allow the simultaneous movement of opposing left turns on the same street without their turning paths conflicting.
- **Maximum efficiency needed** - At isolated locations where fully actuated equipment is used and left turn demands are both variable and unequal. This option allows for maximum left turn flexibility by terminating a left turn when its demand is satisfied and releasing the conflicting through movement.
- **Equal left turn volumes** - When using pre-timed equipment with opposing left turn volumes that are approximately equal.

e. **Split Phase**

This defines the situation when each approach on the same street is serviced separately with green signal indications (See Figure 3-7 Split Phase with Protected Left Turns). It should be noted that split phasing may increase the overall delay at an intersection. Split phasing may be used in the following circumstances:

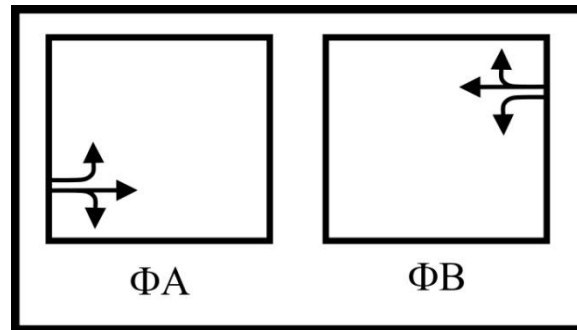

Figure 3-7 Split Phase with Protected Left Turns

- **Inadequate intersection geometry** - At intersections where there is inadequate room for opposing left turn movements on the same street to move simultaneously without conflicting/crossing or the offset of the lanes are inadequate to judge if a vehicle is turning left or going through.
- **Multiple left turn lanes** - On opposing approaches where two or more left turn lanes exist.¹²

¹² Traffic Engineering Handbook, 1999, p.480

f. Yellow Trap

The “yellow trap” occurs in cases where a permissive left turn movement is permitted on an approach and the circular green interval for that left turn movement is terminated while the opposing through traffic movement continues on a circular green indication and a left turn green arrow will be displayed to the opposing left-turn movement. This is called the yellow trap because left turn drivers on the street on which the right-of-way interval is being terminated see circular yellow indications for both the left turn and through movements. The left turning driver facing the circular yellow indication may assume that the opposing through traffic also has circular yellow indications and will therefore be stopping.¹³

A lead/lag left turn sequence should only be applied if the leading left turn display is protected only.¹⁴

If both opposing left turn displays are protected-only, you should only apply a dual lag/lag left turn sequence if max calls are placed on the through phases and min recalls are placed on the left turn phases to insure that the lag turns begin simultaneously.¹⁵

g. Avoiding the Yellow Trap

Trafficware controllers are capable avoiding the “yellow trap.” If for some reason the “yellow trap” cannot be programmed out, the turns must be protected only.

▪ Inhibiting Phases

A Trafficware controller feature which prevents (or inhibits) a phase from being serviced if another specified phase is on. Using standard 8-phase operation, if you inhibit 01 with 02, 03 with 04, 05 with 06 and 07 with 08, you will ensure that the Yellow Trap never occurs in a protected/permitted left turn display. A lagging left turn cannot be used with this option.¹⁶

▪ Detector Sourcing

An important aspect about inhibiting phases is that it prevents the protected-only left turn phases from being serviced before a cross street phase is serviced. This creates a situation where the cross street may be skipped for several cycles and consequently no left turn demand exceeds the available gaps. If this is a concern, the solution is to program a delay detector sourced by the left turn detector to place a minimum call on the cross street. After the

¹³ Traffic Control Devices Handbook, 2001, p. 275

¹⁴ Naztec TecNote 3013, 2000

¹⁵ Naztec TecNote 3013, 2000

¹⁶ Naztec TecNote 3013, 2000

adjustable delay times out, the cross street is serviced for a minimum green time before cycling to the protected left turn phase.¹⁷

- **Protected-Only Lefts**

Another method to eliminate the yellow trap is to utilize a protected-only mode of left turn operation for any leading protected left turn movement on the opposing approach.¹⁸

3.2.4 LADOTD Phase Assignments

LADOTD has adopted the National Electrical Manufacturers' Association (NEMA) phase conventions. Because of the importance of standardizing signal phase assignments, the following signal phase assignments shall be used on plans and Traffic Signal Inventory (TSI) forms.

The determination of which street is the main street is based primarily on the functional class hierarchy presented in the American Association of State Highway and Transportation Officials (AASHTO) Policy on Geometric Design of Highways and Streets¹⁹ and secondarily on the street volumes. The state route takes precedence over the parish route and the parish route takes precedence over the city street. If both routes are of the same functional class, then the route with the highest volume is designated as the main street.

- a. Four-way Intersections**

The following phase assignments shall be the standard for all LADOTD four-way intersections. Phases 5 through 8 will be used as overlaps (OL) as needed.

¹⁷ Naztec TecNote 3013, 2000

¹⁸ Traffic Control Devices Handbook, 2001, p. 276

¹⁹ AASHTO A Policy on Geometric Design of Highways and Streets, 2004, p. 1-8

LA DOTD Phase Assignments 4-Way Intersections

Phase 5 thru 8 use the following overlaps when a 4 phase cabinet is used.

Φ5 - **OLA(5)** Φ7 - **OLC(7)**
 Φ6 - **OLB(6)** Φ8 - **OLD(8)**

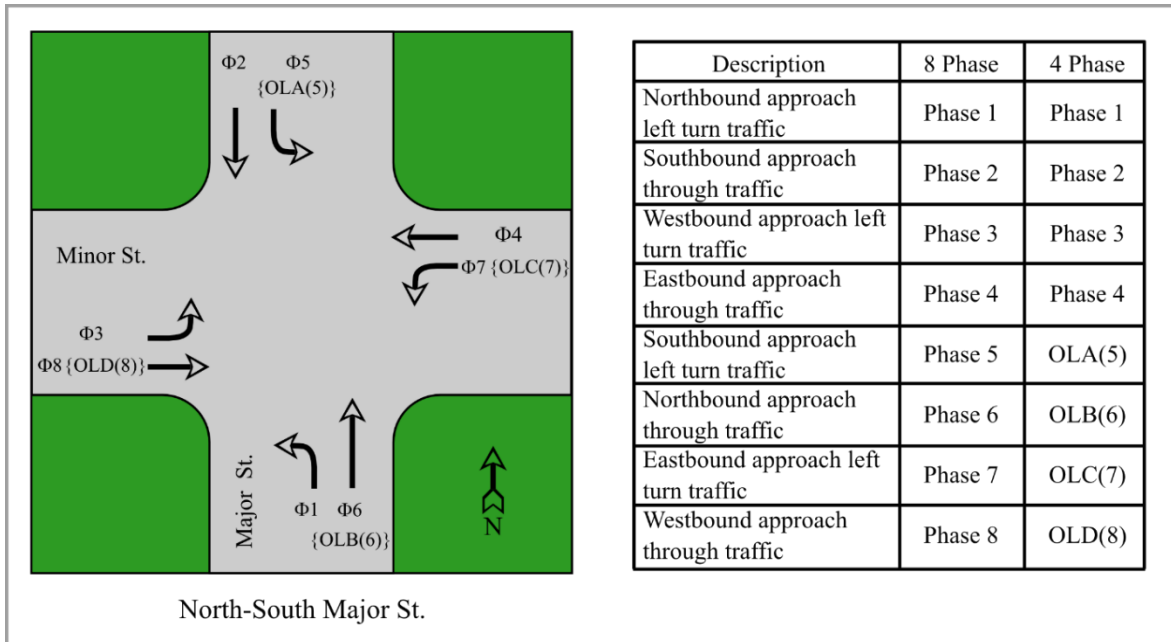

Figure 3-8 Phase Assignments - 4-Way Intersection (N-S Main St.)

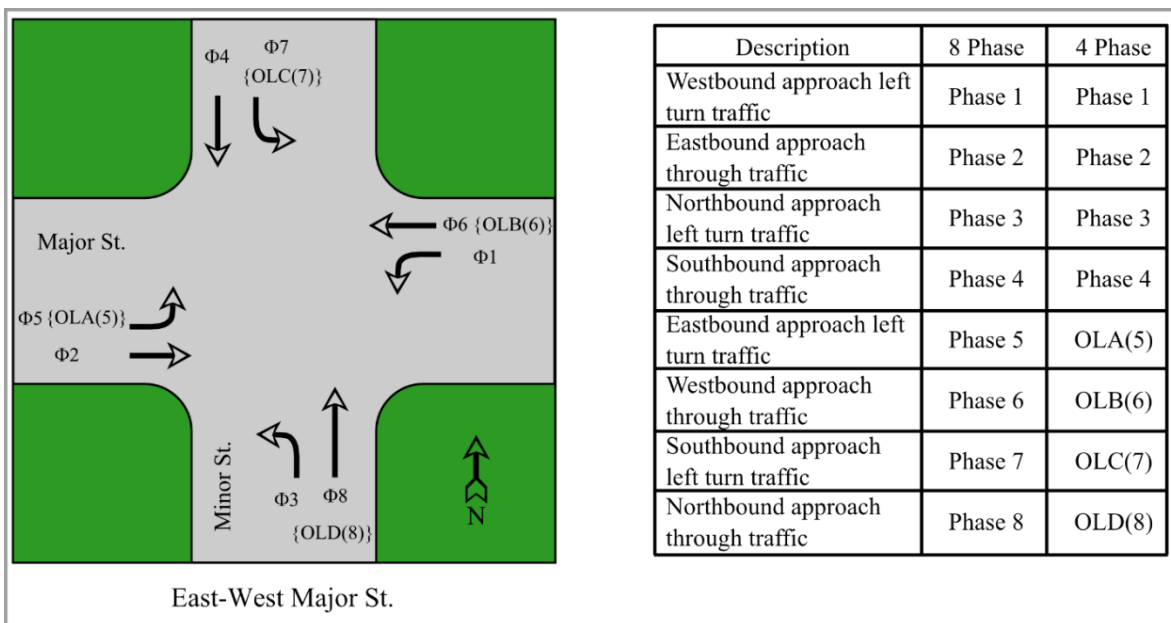

Figure 3-9 Phase Assignments - 4-Way Intersection (E-W Main St.)

b. "T" Intersections

The following phase assignments shall be the standard for all LADOTD "T" intersections. Phases 5 through 8 will be used as overlaps (OL) as needed.

LA DOTD Phase Assignments T - Intersections

Phase 5 thru 8 use the following overlaps when a 4 phase cabinet is used.

Φ5 - **OLA(5)** Φ7 - **OLC(7)**
 Φ6 - **OLB(6)** Φ8 - **OLD(8)**

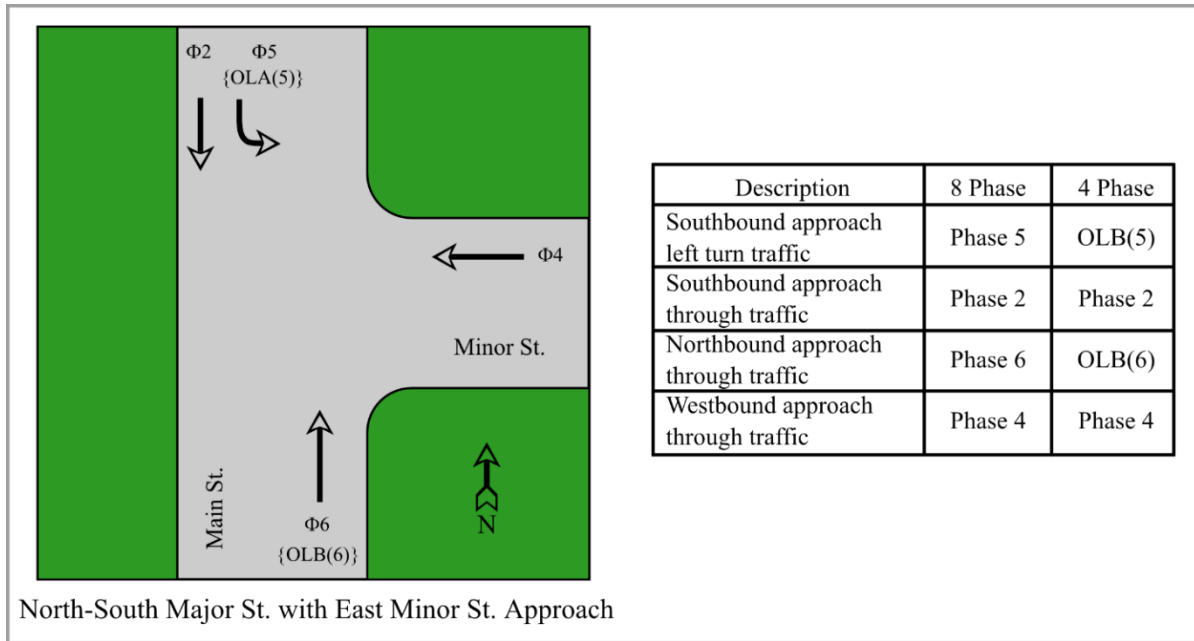

Description	8 Phase	4 Phase
Southbound approach left turn traffic	Phase 5	OLB(5)
Southbound approach through traffic	Phase 2	Phase 2
Northbound approach through traffic	Phase 6	OLB(6)
Westbound approach through traffic	Phase 4	Phase 4

Figure 3-10 Phase Assignments - T-Intersections (N-S Main St. with East Minor St. Approach)

LA DOTD Phase Assignments T - Intersections

Phase 5 thru 8 use the following overlaps when a 4 phase cabinet is used.

Φ5 - **OLA(5)** Φ7 - **OLC(7)**
 Φ6 - **OLB(6)** Φ8 - **OLD(8)**

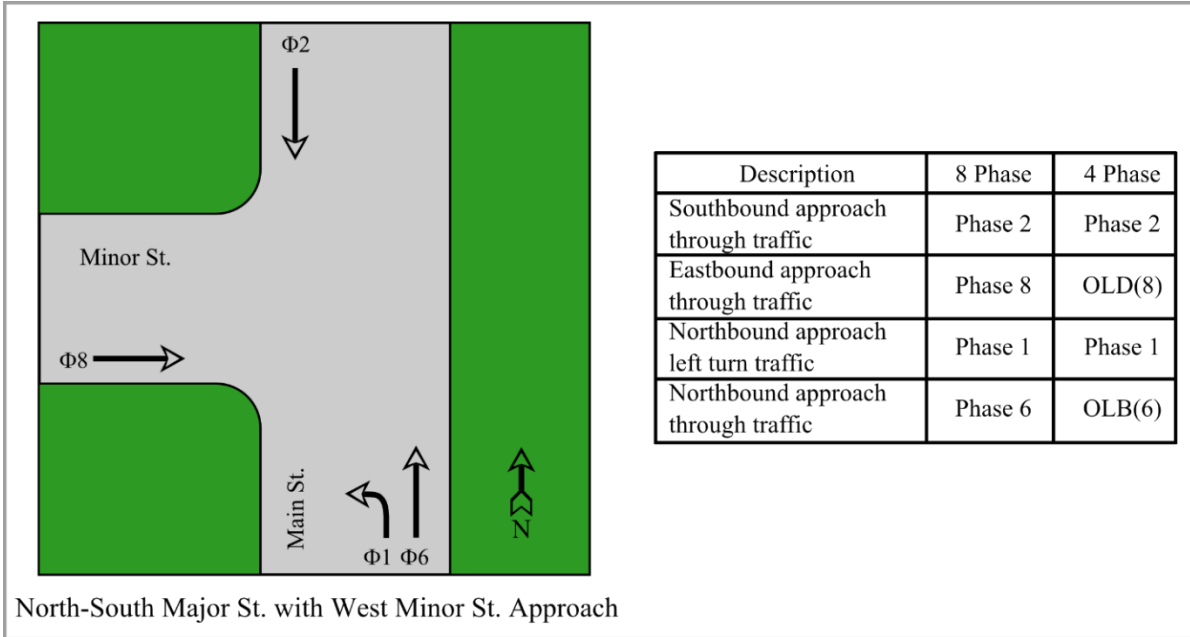

Figure 3-11 Phase Assignments - T-Intersections (N-S Main St. with West Minor St. Approach)

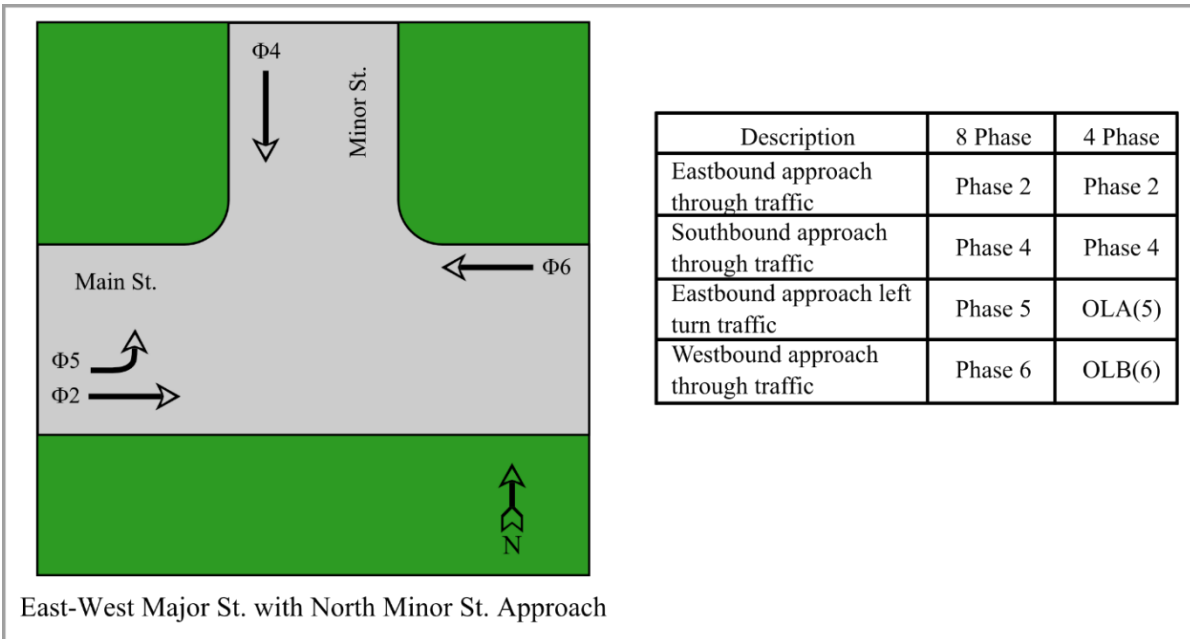

Figure 3-12 Phase Assignments - T-Intersections (E-W Main St. with North Minor St. Approach)

LA DOTD Phase Assignments T - Intersections

Phase 5 thru 8 use the following overlaps when a 4 phase cabinet is used.

Φ5 - **OLA(5)** Φ7 - **OLC(7)**
 Φ6 - **OLB(6)** Φ8 - **OLD(8)**

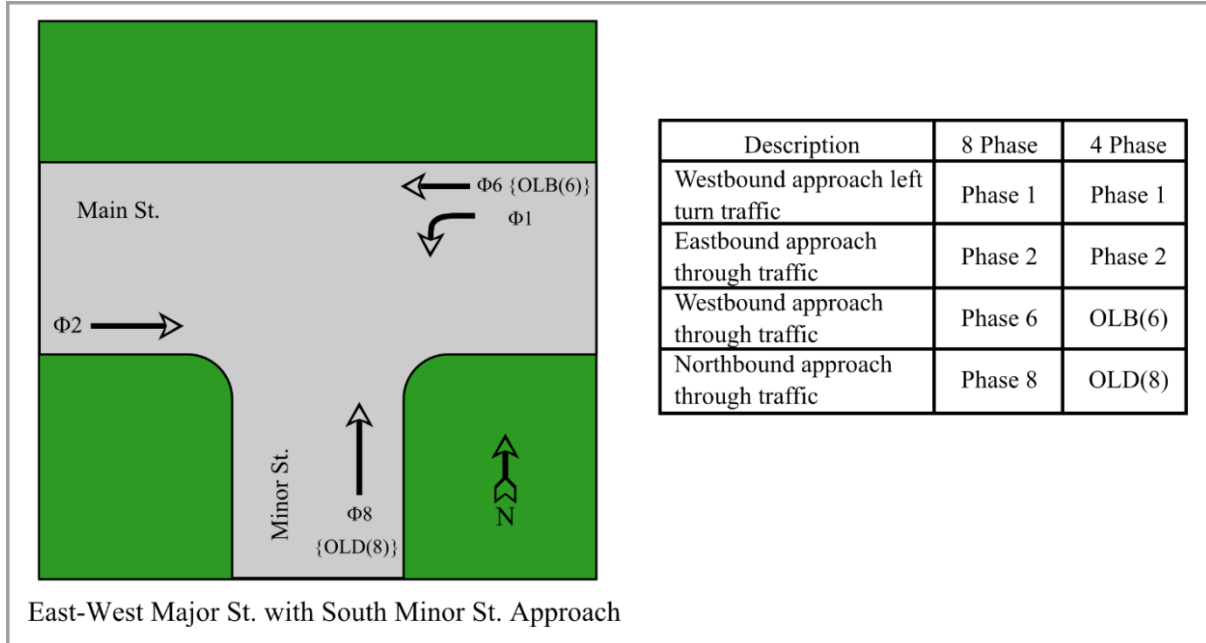

Figure 3-13 Phase Assignments - T-Intersections (E-W Main St. with South Minor St. Approach)

3.3 SIGNAL TIMING

The functional objective of signal timing is to alternate the right of way among the various phases in such a way as to²⁰:

- **Provide for the orderly movement of traffic**
- **Minimize average delay to vehicles and pedestrians**
- **Reduce the potential for crash-producing conflicts**
- **Maximize the capacity of each intersection approach.**

All signal timings shall be approved by the DTOE, because the DTOE is responsible for maintaining the signal and ensuring peak performance.

3.3.1 Timing for Pre-timed Control

Pre-timed signal operations must take into account a number of local intersection variables and hardware characteristics. It is therefore difficult to set forth comprehensive guidelines to fit all possible situations. In many situations, it is desirable to monitor the initial operations and adjust the timing settings to reflect the unique character of the intersection and traffic flow.²¹

a. Timing Plans

A timing plan may be defined as a unique combination of cycle length (commonly ranging from 40 to 120 seconds), split, and possibly offsets. Traffic demand at the intersection is the critical determinant of the number of timing plans required. Traffic demand patterns typical at a majority of locations may be categorized as but not limited to:

- **A.M. peak period**
- **Average day (midday) period**
- **P.M. peak period**
- **Night (low-flow) period**
- **Weekend or special functions periods**
- **Emergency Evacuation**
- **Special Events**

It can be generally assumed that a minimum of three (3) timing plans will be required: two for peak conditions (AM and PM) and one for off-peak conditions (Free Operation).²² The Designer should always check with the DTOE for needed timing plans.

²⁰ Manual of Traffic Signal Design, 2nd ed., 2006, p. 139

²¹ Manual of Traffic Signal Design, 2nd ed., 2006, p. 140

²² Manual of Traffic Signal Design, 2nd ed., 2006, p. 142

b. Phase-Change Interval

The critical function of the phase-change interval is to warn traffic of an impending change in the right-of-way assignment. The minimum yellow change interval is computed to provide adequate time to alert drivers of the need to stop for the forthcoming red light. The total minimum change period (yellow and red) clearance intervals should be determined and implemented as follows and shall be part of the engineering report. Times are to be rounded to the nearest tenth of a second.

$$CP = t + [v/(2a + 2gG)] + [(w + l)/v]$$

FIRST TERM
"Yellow"

SECOND TERM
"All Red"

CP = Yellow time plus all red time (sec.)

t = Driver Perception/reaction time (generally, 1 sec.)

v = Approach speed (ft/sec.)

a = Average Deceleration (values between 10 ft/sec^2 & 15 ft/sec^2)

g = Acceleration due to gravity (32.2 ft/sec^2)

G = Grade (percent/100)

w = Cross street width

l = Vehicle length (assumed to be 20 ft.)

			TOTAL CHANGE PERIOD (YELLOW AND RED) CLEARANCE INTERVALS								
SPEED LIMIT		FIRST TERM	INTERSECTION WIDTH IN FEET								
			FIRST TERM + SECOND TERM FOR VARIOUS CROSS STREET WIDTHS								
MPH	ft/sec	$t+[v/(2a+2gG)]$	40	45	50	55	60	65	70	75	80
30	44.00	3.20	4.56	4.68	4.79	4.90	5.02	5.13	5.25	5.36	5.47
35	51.33	3.57	4.74	4.83	4.93	5.03	5.13	5.22	5.32	5.42	5.51
40	58.67	3.93	4.96	5.04	5.13	5.21	5.30	5.38	5.47	5.55	5.64
45	66.00	4.30	5.21	5.28	5.36	5.44	5.51	5.59	5.66	5.74	5.82
50	73.33	4.67	5.48	5.55	5.62	5.69	5.76	5.83	5.89	5.96	6.03
55	80.67	5.03	5.78	5.84	5.90	5.96	6.03	6.09	6.15	6.21	6.27
60	88.00	5.40	6.08	6.14	6.20	6.25	6.31	6.37	6.42	6.48	6.54
65	95.33	5.77	6.40	6.45	6.50	6.55	6.61	6.66	6.71	6.76	6.82

* FOR SPEED LIMIT OF 55 MPH OR LESS, AND WHERE THE VALUES ABOVE ARE HIGHLIGHTED IN GRAY, THE YELLOW INTERVAL SHALL BE 5.0 SECONDS, AND THE ALL RED SHALL BE THE VALUE IN THE ABOVE TABLE MINUS 5.0 SECONDS. FOR EXAMPLE, FOR A 45 MPH ROADWAY WITH AN INTERSECTION WIDTH OF 70 FEET, THERE ARE 5 SECONDS OF YELLOW TIME WITH AN ADDITIONAL 0.66 SECONDS OF ALL RED TIME. THE RED TIME WOULD BE ROUNDED TO 0.7 SECONDS.

* FOR SPEED LIMIT OF 60 MPH, THE YELLOW INTERVAL SHALL BE NO LESS THAN 5.4 SECONDS, AND THE ALL RED SHALL BE THE VALUE IN THE ABOVE TABLE MINUS 5.4 SECONDS. FOR EXAMPLE, FOR A 60 MPH ROADWAY WITH AN INTERSECTION WIDTH OF 70 FEET, THERE ARE 5.4 SECONDS OF YELLOW TIME WITH AN ADDITIONAL 1.02 SECONDS OF ALL RED TIME. THE RED TIME WOULD BE ROUNDED TO 1.0 SECONDS.

* FOR SPEED LIMIT 65 MPH, THE YELLOW INTERVAL SHALL BE NO LESS THAN 5.8 SECONDS, AND THE ALL RED SHALL BE THE VALUE IN THE ABOVE TABLE MINUS 5.8 SECONDS. FOR EXAMPLE, FOR A 65 MPH ROADWAY WITH AN INTERSECTION WIDTH OF 70 FEET, THERE ARE 5.8 SECONDS OF YELLOW TIME WITH AN ADDITIONAL 0.91 SECONDS OF ALL RED TIME. THE RED TIME WOULD BE ROUNDED TO 0.9 SECONDS.

* A 1 SECOND RED TIME SHOULD BE PROVIDED WHEN POSSIBLE.

Table 3-1 Theoretical Minimum Clearance Intervals

c. Cycle-Length Calculations

The time required to complete a prescribed sequence of phases is known as the cycle length. There are various techniques that may be applied to establishing cycle length. The sum of computed green times, yellow times, and all-red times equals the cycle length. This sum is usually adjusted upward to a number divisible by 5. The steps for calculating cycle length are as follows:

- a. Select yellow change intervals.
- b. Calculate all-red times.
- c. Determine pedestrian clearance times if needed.
- d. Compute minimum green times.
- e. Compute other green time.
- f. Adjust cycle length.
- g. Prepare interval chart.

To assure that critical lane volumes will be adequately serviced, a capacity check should be conducted for each green time. The last step is to sequence the various intervals and compute the percentage values so that the timing parameters can be implemented on the local controller. The designer should keep in mind when cycle-length is being determined for a coordinated corridor that the cycle-length may be determined by the corridor as a whole.

3.3.2 Timing for Actuated Control

The principles involved in timing actuated control equipment are somewhat similar to those used for pre-timed control. Procedures for determining phase-change intervals and pedestrian intervals for pre-timed control also apply to an actuated control. Cycle length in actuated control may vary from cycle to cycle and the split depends upon the relative demand during the various phases. There are three types of operational modes associated with particular types of actuated equipment: non-actuated modes (used with semi-actuated control), actuated modes, and volume-density modes. Timing for each mode of operation is discussed below.

a. Non-actuated Mode²³

In semi-actuated operation, the major street normally operates in a non-actuated mode. That is, green will remain on the major street for the predetermined minimum time and thereafter until there is a vehicular or pedestrian call for service from a conflicting phase. Timing of the non-actuated mode provides a guaranteed minimum green on the major street before a conflicting call for service

²³ Manual of Traffic Signal Design, 2nd ed., 2006, p. 150

will be accommodated. The cycle length is variable and is a function of the demand from the side street.

The length of the guaranteed green for the major street depends on the type of intersection. Where there are only occasional vehicles on the side street and the primary street is a secondary arterial, relatively short settings (25 to 40 seconds) may be used. In contrast, where the side street discharges large numbers of vehicles at times with almost no demand at other times, the guaranteed green setting for the major street may be quite long (40 to 75 seconds). In addition to the setting for guaranteed minimum green time, there are settings for the yellow change and all-red clearance intervals for the non-actuated phase.

In a systems operation, the cycle length is fixed and will only allow a given part of the cycle to be used by the side street. Only the time actually required by side-street traffic will be assigned. The remaining time, if any, will be allocated to the non-actuated phase when the controller has force-offs are set to float. If the controller has force-offs set to fixed, then all spare time will be given to the next phase.

b. Actuated Mode²⁴

When using actuation the following parameters must be set: the Minimum Green, the Gap, Extension, the Max-1 Green, and Minimum Vehicle Recall. (Maximum Vehicle Recall should not be set in this mode.)

i. Minimum Green

The minimum green time defines the minimum duration of the green interval for each phase. When setting the minimum green time, the storage of vehicles between the advance detection (setback detection), and the stop-bar for the associated approach should be considered. The use of flashing yellow arrows should also be considered, as the minimum green cannot be less than 5 seconds in order to accommodate the required 3 second delay for flashing yellow arrows. The minimum green interval is established to permit those vehicles stopped between the detection point and the stop bar to get started and move into the intersection.

The minimum green interval can also be used to artificially ensure adequate pedestrian crossing time. This means that the interval must be set equal to the time required for a pedestrian to safely cross the street. Be aware that when doing this that signal efficiency can suffer.

²⁴ Manual of Traffic Signal Design, 2nd ed., 2006, p. 151-155

ii. Gap, Extension

The Gap, Extension, also known as passage time, determines the extendable portion of the green interval. The Gap, Extension is timed to permit the vehicle to travel from the setback detector to the intersection. This interval defines the maximum apparent time gap that can occur without losing the green indication.

For maximum efficiency, the Gap, Extension time should be set as short as practically possible. That is, the green indication should be retained only as long as a real and consistent demand is present, but should not be expected to service stragglers.

iii. Max-1 Green, Max-2 Green and Max Inhibit

The maximum green interval limits the time a phase can hold the green. Ordinarily, maximum intervals are set between 30 and 60 seconds.

One method for determining maximum intervals for each phase is to compute optimum cycle length and green times in the same way these intervals are determined for pre-timed controllers.

In addition to the Max-1 Green setting, there is also Max-2 Green and Max Inhibit. Max-2 Green provides an additional maximum green time for cases when a larger green time is needed for a portion of the day. In cases where coordination is being used with larger split times than Max-1 and Max-2 Green, the Max Inhibit setting can be enabled. This setting allows the controller to run using the larger split time without conflicting with the existing Max-1 and Max-2 Green times.

iv. Minimum Vehicle Recall

The Minimum Vehicle Recall setting must be set for the signal to return to the Minimum Green time. This allows the phase to start at the Minimum Green time and increment to the Max-1 or Max-2 Green based on detector activation.

c. Volume-Density Mode

The passage time for a volume-density mode phase is set based on the time required to travel from the detector to the stop line. The passage time is normally longer than the desired maximum gap. Advanced NEMA controllers have a gap-reduction feature that uses three settings: Time Before Reduction, Time to Reduce, and Minimum Gap.

The Time Before Reduction period begins during the green phase when there is a serviceable conflicting call. There is a linear reduction in the allowable gap from the passage time to the “minimum gap.” The rate reduction is based on the difference between the passage time and the minimum gap divided by the “time to reduce” setting. This procedure is shown in Figure 3-14 Gap Reduction Timing. The reduction in allowable gap continues during the time to reduce until a gap greater than the current reduced gap occurs (which means the phase will change) or the minimum gap is reached. From that point on, the minimum gap controls the phase until the maximum period is reached.²⁵

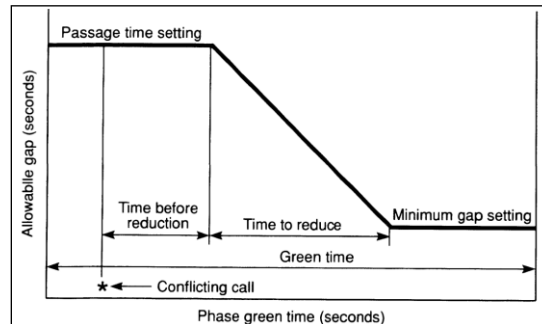

Figure 3-14 Gap Reduction Timing

d. Pedestrian Timing

These are signal timings to account for pedestrians at a signalized intersection. This can include a special signal sequence actuated by pedestrian push buttons or a timing included in the vehicular phases. Based on the following warrants, the pedestrian signal phase may or may not have push buttons or pedestrian signal heads. Push buttons may be used without pedestrian signal heads if the traffic signal heads can be seen. If the signal has a pedestrian push button or pedestrian signal heads the crossing must have a marked crosswalk.

When warrants are met for pedestrians a signal designer should work with roadway designers to see about including pedestrian refugees for multi-lane roadways. If a pedestrian is crossing more than six lanes of traffic a pedestrian refuge should be provided for a staged crossing. If it is a divided highway a staged crossing should be provided.

²⁵ Manual of Traffic Signal Design, 2nd ed., 2006, p. 154

i. **Warrants** - The DTOE shall approve all pedestrian equipment.

1. Pedestrian Push Button

For locations where a sidewalk with tactile warnings are in place an accessible pedestrian detector shall be installed. All other locations may have pedestrian push buttons installed based on the traffic signal timing plan when Engineering Judgment indicates the need (Engineering Judgments would need to be explained in a report or study).

2. Pedestrian Countdown Signal Head

A pedestrian signal phase with pedestrian signal heads may be included in the traffic signal design when a marked crosswalk or push button is justified by Engineer's Reports.

3. Rectangular Rapid-Flashing Beacons (RRFB)

See the [Federal Highway Administration Interim Approval 21](#) for more information related to RRFB.

4. Pedestrian Hybrid Beacon

See MUTCD Chapter 4 for information related to Pedestrian Hybrid Beacons.

ii. **Sequence**

1. Concurrent Movement

The most commonly used sequence is to move pedestrians concurrent with parallel vehicular traffic. Care must be taken to not move pedestrians during the display of a conflicting left turn or right turn arrow for the parallel vehicular traffic.

2. Leading Pedestrian Interval (LPI)

See MUTCD Chapter 4 for information related to leading pedestrian interval.

iii. Pedestrian Timings

LADOTD prefers that all signal pedestrian timings remain within the green portion for the corresponding through phase. The DTOE shall approve any pedestrian timings that will continue into the clearance intervals for the corresponding through phase.

1. Walk

Where pedestrians who walk slower than 3.5 feet per second or pedestrians who use wheelchairs routinely use the crosswalk, a walking speed of less than 3.5 feet per second should be considered in determining the pedestrian clearance time. The walk interval should be at least 7 seconds in length so that pedestrians will have adequate opportunity to leave the curb or shoulder before the pedestrian clearance time begins. If pedestrian volumes do not require a 7-second walk interval, walk intervals as short as 4 seconds may be used with proper justification and DTOE approval.²⁶ Where large groups of pedestrians cross, field observation should be used to see how long it takes the group to leave the curb. Avoid shortening the WALK phase to improve the flow of right turning vehicles. For coordinated signal systems, extend the WALK phase to full green time minus the Flashing DON'T WALK phase.

2. Pedestrian Clearance (Flashing DON'T WALK)

Where pedestrian timings are provided, the pedestrian clearance Flashing DON'T WALK provides the time necessary for a pedestrian to cross the street from the curb line to the center of the farthest travel lane or to a median of sufficient width for pedestrians to wait. A maximum walking speed of 3.5 feet per second is assumed but depending on the characteristics of the pedestrians at the crossing a minimum speed of 2.5 feet per second or greater is acceptable. It is calculated using the equation.

$$\text{PED CLR} = \frac{W}{V_P}$$

Where: PED CLR = Pedestrian Clearance (sec.)

W = width of the street (curb line to center of farthest lane or to the median)(ft.)

V_P = pedestrian walking speed (2.5ft./sec. to 3.5ft./sec.)

²⁶ MUTCD, 2009, Part 4, p.498, Section 4E.06 Par.10, 11, and 12

3. Pedestrian Clearance (“Steady” DON’T WALK)

Where pedestrian timings are provided, the pedestrian clearance Steady DON’T WALK is the time where pedestrians should be out of the street. This is usually equal to the vehicular yellow and all red clearances. For additional information related to pedestrian timings see the MUTCD.

4. Signals Without Pedestrian Actuation

Where pedestrians are a consideration but pedestrian signals and push buttons are not provided, the minimum green for the concurrent parallel vehicular movement, must be at least equal to the sum of the calculated walk and pedestrian clearance Flashing DON’T WALK for that crossing.

iv. Pedestrian Push Button Placement

All pedestrian push button installations shall follow MUTCD Chapter 4 Section 4E.08 (Pedestrian Detectors) and Section 4E.10 (Accessible Pedestrian Signals and Detectors – Location). In order to maintain a pedestrian’s expectation for accessible pedestrian push button interaction, speech messages shall be used at all push button locations when a design requires speech messages for at least one crossing. The designer shall include a note on plans when speech messages will be used.

For locations where pedestrian push buttons are being installed at a pedestrian refuge the designer should consider how an individual will interact with the signal and the signal timings. If a staged crossing is to be used than a designer shall provide the required number of pedestrian push buttons. The designer should also evaluate the arrows, tactile feedback and other devices used for accessible pedestrians to properly communicate how the signal is operating.

Each push button shall be supplemented by sign R10-3a, R10-3b, R10-3c, R10-3d or R10-3e. Use of signs shall be as defined in the MUTCD.

1. Undivided Roadways

When pedestrian push buttons are used they shall be provided on the appropriate corners with a separate push button for each crossing direction if the warrants in Section i (Pedestrian Timings) are met in this chapter.

2. Divided Roadways

On divided roadways where pedestrian push buttons and/or signals are used, pedestrian push buttons and/or signals are also to be

installed in the median area if the median is of sufficient width to safely store pedestrians. The ideal median width is 6 feet with a minimum 5 feet cut or ADA compliant ramp. The minimum median width is 4 feet. If the median area is not designed to accommodate pedestrians then the amount of pedestrian clearance time provided shall provide adequate time to cross the entire street. Median push buttons are to be supplemented with the appropriate sign and may require a double arrow. For information on marked crosswalks, see LADOTD's Traffic Engineering Manual.

v. Miscellaneous

1. When possible signalized intersections that have marked crosswalks should be designed with tight corner radii and without free rights. However, truck movements shall be considered.
2. If a signal has a permitted left turn phase one signal head may be located above the pedestrian signal head whenever possible, to focus the driver's attention on the crosswalk and pedestrian signal indication. It will also help alert pedestrians to the presence of left turning vehicles.
3. "No Right Turn on Red" restrictions may be used to reduce pedestrian-vehicle conflicts at locations with high numbers of pedestrians and right turning vehicles.

3.3.3 Signal Timings and Flashing Yellow Arrows

All left turn flashing yellow arrows shall be installed with a three (3) second delay. This three (3) seconds is intended to allow the opposing thru movement time to begin moving and thus reinforcing to the left turner that the opposing thru has a green indication and that they must yield. An example for a left turn flashing yellow arrow head indications with the three (3) seconds delay included is provided in Figure 2 – FYA Indication Order. These example follows the signal indication requirements stated in the MUTCD. For more information about the flashing yellow arrow signal indication requirements see MUTCD Section 4D.20 p.471.

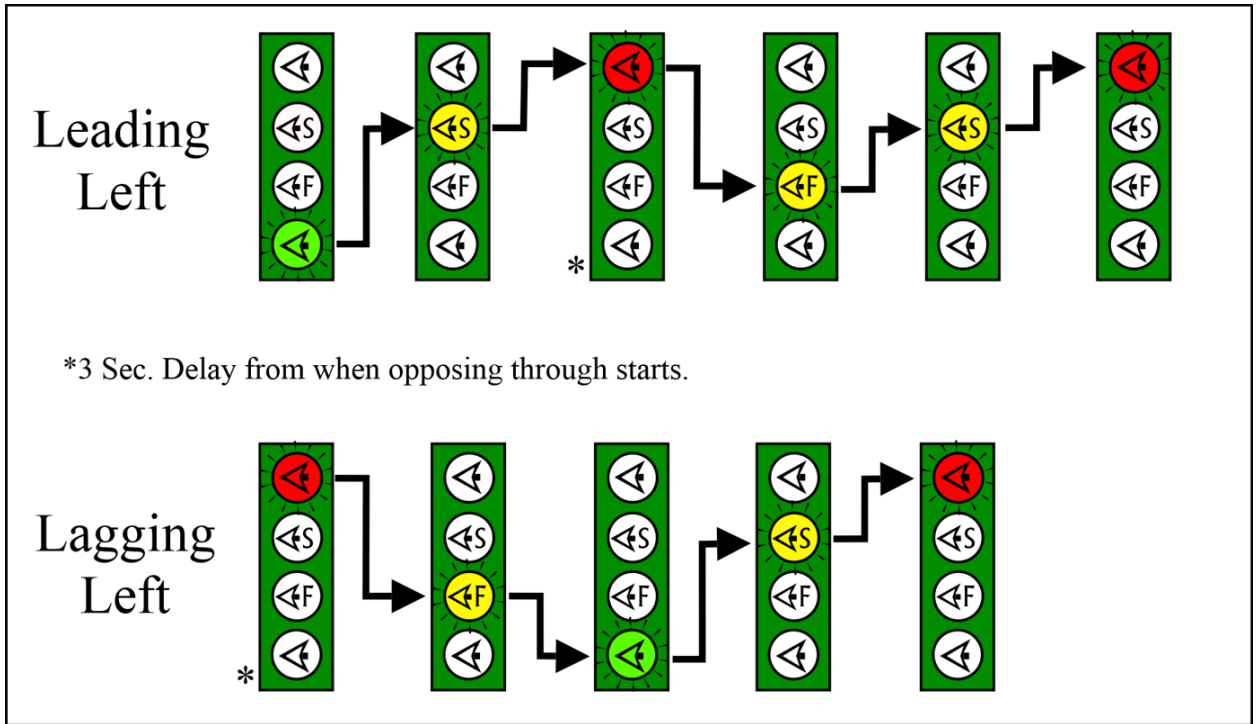

Figure 3-15 - FYA Indication Order

3.4 PREEMPTION

3.4.1 Highway/Rail Signal Preemption Guidance

Synchronizing the railroad crossing warning devices with the traffic signal is referred to as “preemption.” The design of the timing for these signals varies from simple to complex, depending on numerous factors that may exist at or near the crossing and intersection. Coordination between the District Traffic Operations Engineer (DTOE), Railroad personnel, and LADOTD’s Highway/Rail Safety Engineer (HRSE) is essential.

The preemption procedures are as follows:

- a. Whenever the LADOTD Traffic Engineer, DTOE or DTOE staff is evaluating an existing or proposed traffic signal for preemption, they shall perform field observations to determine the queue lengths, clearance times and other pertinent information regarding the crossing and intersection. It is also important to gather input and information on the railroad crossing from the HRSE and the Railroad representative. Railroad crossing information should include the crossing’s DOT No. and train information (train speed, etc.).

- **Warrant**

The coordination of the operation of a traffic signal with a nearby railroad grade crossing equipped with flashing lights and gates may be justified under the following conditions.

- **Where the at-grade crossing is located within 200 feet of the traffic signal, preemption should be used. At a minimum, preemption shall include prohibiting movement across the tracks with blank out signs and/or special phasing. Observations shall be made to determine the length of queues and if necessary, the time required to clear the track. Such observations may be verified with calculations.**
- **Where the at grade crossing is located more than 200 feet from the signal but traffic from the signal is observed to back up across the railroad tracks, preemption should be used. Preemption shall include prohibiting movement across the tracks with blank out signs and/or special phasing, and timing to clear the track. Observations shall be made to determine the time required to clear the track. Such observations may be verified with calculations.**
- **When traffic stopped for a train at the grade crossing frequently backs up into a nearby signalized intersection, preemption may be considered.**

- **Field Observation Method**

Several computational methods are available for the estimation of queue lengths and queue clearance times for railroad preemption. The results of these calculations can vary significantly from each other and more importantly from observed values. Only observation of actual conditions can account for the numerous variables associated with roadway geometry, local driver behavior, traffic mix, etc. Accordingly, the queue lengths and queue clearance design values for preemptions shall be based on observed values. Computations may also be necessary for future intersections or traffic conditions which do not presently exist and a similar location cannot be found to observe.

- **Preemption Sequence**

The preemption sequencing of a two phase signal is shown in Figure 3-16. As shown the basic phases of the sequence are, a right-of-way change interval, a clear track interval and preemption hold phasing (while the train is occupying the crossing).

- **Blank Out Signs**

This type of sign displays a blank face unless internally illuminated upon activation at a specific time. Such signs displaying the message/symbol “No Left Turn” or “No Right Turn” are useful as part of the railroad preemption sequence at signalized intersections immediately adjacent to grade crossing. (See Figure 3-16) At such locations, turn prohibition blank out signs would prevent traffic from turning into and occupying the limited storage area between the tracks and intersection and eventually blocking the intersection itself.

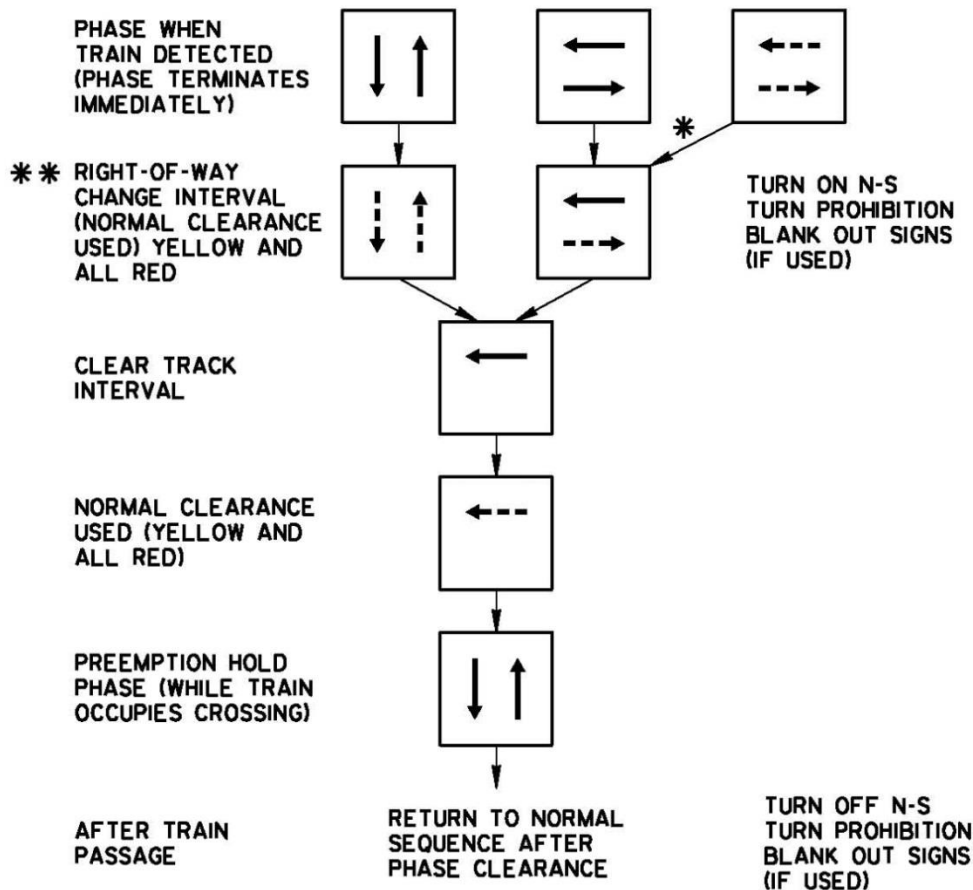
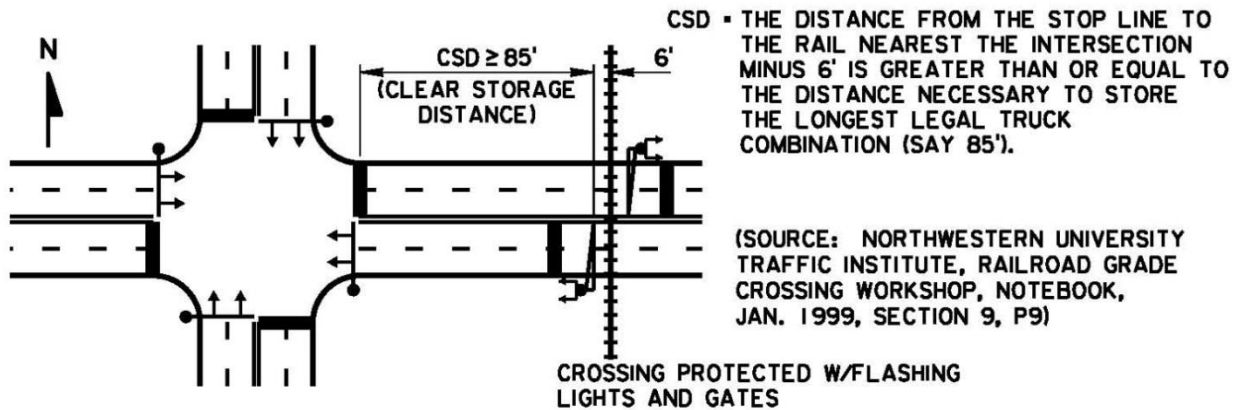

* NOTE: YELLOW SIGNAL RETURN TO GREEN MINUS ALL RED ALLOWED BY 2009 MUTCD IN THIS SITUATION.

* * NOTE: IF PEDESTRIAN PHASES ARE PRESENT, THE 2009 MUTCD ALLOWS THE WALK AND/OR PEDESTRIAN CLEARANCE INTERVALS TO BE SHORTENED OR OMITTED DURING THE TRANSITION INTO PREEMPTION, ENGINEERING JUDGEMENT MUST BE USED.

Figure 3-16 Typical Railroad Preemption Sequence for 2 Phase Operation

- **Turn Arrows**

Turn phases with arrow indications which conflict with the railroad preemption, shall be omitted until the train has cleared the railroad crossing.

- **Field Observation Procedure**

The following queue/clearance field observation method provides a method to directly measure the saturation flow rates.²⁷

The queue/clearance field observation procedure requires the survey of intersection geometry and the measurement of queue lengths and clearance times. The survey and measurements can be performed by a single technician; however, a two-person crew would reduce fatigue as well as possible error. The field notes and tasks identified in the following section should be adjusted according to the type of equipment used. Necessary equipment includes a measuring wheel (or tape), a stopwatch, and a Track Clearance Worksheet, Figure 3-17.

Review existing traffic counts and select a time period during which the queue lengths are expected to reach the tracks. In order to obtain a statistically significant value, a minimum of 15 signal cycles with queues extending into the track dynamic envelope (See Figure 3-17) are required. Queues should be checked for through lanes as well as turn lanes. For tracks that are fairly close to the intersection, queue measurements can be made at any time of day. For locations where the tracks are 200 feet or more from the tracks, queues may only extend back to the tracks during the AM, noon, or PM peaks. Notes should be made concerning the number of attempts made to observe queue lengths. If queues are expected, but do not occur after three separate attempts during AM and PM peak, track clearance will not be an issue in the preemption design at this location.

²⁷ Highway Capacity Manual, 2010, Volume 4, Chapter 31, Page 31-104

**LaDOTD TRAFFIC OPERATIONS AND ENGINEERING
FIELD OBSERVATION METHOD
RAILROAD PREEMPTION WORKSHEET**

General Information

Analyst _____	Date _____
District _____	Time _____
Parish _____	Area Type: ___ rural, or ___ urban
TSI No. _____	

Geometric Input

Route _____
St Name _____

Dynamic Envelope _____
Distance Between Envelope and Stop Bar _____

Route _____
St Name _____

Railroad Co. _____
Mainline _____ or Spur _____
Number of Tracks _____
Dynamic Envelope _____ ft
Distance Between Envelope and Stop Bar _____ ft
Railroad Control: _____ Crossbucks
_____ Lights/Ground
_____ Lights/Truss
_____ Gates

Input Field Measurement

Cycle	Queue at start of Green				Last Vehicle in Envelope		
	Total Number of Vehicles	Number of Passenger Vehicles	Number of Single Unit Vehicles	Number of Tractor Trlr Vehicles	Is a Vehicle stopped in envelope?	N th Vehicle	Time to Clear Envelope
1					Yes No		
2					Yes No		
3					Yes No		
4					Yes No		
5					Yes No		
6					Yes No		
7					Yes No		
8					Yes No		
9					Yes No		
10					Yes No		
11					Yes No		
12					Yes No		
13					Yes No		
14					Yes No		
15					Yes No		
Maximum							
Minimum							
Average							

Glossary and Notes

- Dynamic Envelope - Typically 18 ft for 90 deg crossing, 6 ft track width plus 6 ft clearance on either side.
- Single Unit Vehicles - Delivery Trucks and Busses
- Tractor Trlr - Tractor Trailer Vehicles
- N th Vehicle - The last vehicle that stops for the signal and is in (or just before) the Dynamic Envelope.
- Time to Clear - Time from start of green until back of Nth Vehicle clears Dynamic Envelope.

rev 5/02

Figure 3-17 Track Clearance Worksheet

- **Field Measurement**

- Fill out the General Information data on the Track Clearance Worksheet.
- Measure and record the Geometric Input data for the site being studied.
- Select an observation point where the track dynamic envelope and the corresponding signal heads are clearly visible.
- As the queue builds during the red phase, record the number and types of vehicles in the queue.
- Note number (1st, 2nd, 3rd ...) of the nth vehicle which is stopped in the track dynamic envelope. If no vehicle stops in the envelope, record the nth vehicle at the end of the queue.
- When the light turns green, start the timer. When the rear bumper of the nth vehicle clears the dynamic envelope, stop the timer. Record the time. If no vehicle stops on the tracks, the time should be left blank.
- Note any unusual events that may have influenced the track clearance time such as buses receiving or discharging passengers, stalled vehicles, unloading trucks, accidents, etc. These observations shall be discarded and not utilized in the queue length and track clearance results.
- The design values for queue length shall be based on the maximum observed value for a minimum of 15 cycles.

- **Clear Track Yellow Change**

The normal yellow timing for this phase is used.

- **Red Clearance**

The normal all red timing for this phase is used.

- **Results**

If the queue is not observed to extend to the tracks, then track clearance should not be included in the preemption timing. If the queue is observed to extend to the tracks on one or more occurrences, then track clearance shall be included in the preemption timing. The queue clearance value shall be the maximum observed value.

- b. When it is not feasible to perform the field observation, the DTOE should choose another crossing with similar characteristics to perform the field review or request suggestions from the HRSE. Only in rare cases should calculations be used other than to verify observations.
- c. Because Louisiana Law RS 32:171 states that “no person shall stop a motor vehicle upon any railroad crossing,” ‘Simultaneous Preemption’ is recommended. In this situation, the traffic signal is activated at the same time as the crossing warning device. The flashing lights further warn the driver not to enter into the Railroad crossing.

- d. When the required preemption timings are determined a letter is to be sent by the DTOE to the HRSE. The letter states the required preemption time and if the signal is ready for preemption. If the signal requires upgrading/modifications then the DTOE will state either the related project number or that Traffic Engineering and Services will be performing the work. An example of this letter is shown in the Appendix.
- e. After the DTOE timing findings are formally submitted in the Traffic Signal Inventory (TSI), a meeting at the crossing will be held between LADOTD, the Railroad and local jurisdiction, as applicable. This meeting will be coordinated by the District with input from the LADOTD's Railroad Safety Unit. This meeting will discuss the issues to resolve for railroad preemption relative to the traffic signal, railroad warning, funding and connection between traffic signal and railroad's active warning. The railroad is to provide the connection to the edge of the railroad's right-of-way. The required conduit work will be done by Railroad employees or contractors; they can be reimbursed by LADOTD/Railroad agreement handled by the LADOTD Railroad Safety Unit.
- f. Once the traffic signal and railroad active warning devices are actually interconnected for preemption, a field test of the system is to be performed by the appropriate LADOTD, Railroad and local jurisdiction as applicable. This date will be recorded and provided to the Railroad and LADOTD's Railroad Safety Unit.
- g. Once the preemption is operational, this connection will be noted in the applicable LADOTD databases. The Railroad may be required to set up periodic field meetings with LADOTD and local jurisdiction, as applicable, to verify the preemption is still working as installed. Also, if the site was one where it was not feasible to perform field review timing calculations, the DTOE or DTOE staff will perform a field observation of the site to see if any changes are recommended within six months of installation. If any changes are recommended by the DTOE the HRSE will need to approve and coordinate the changes.

Railroad Preemption Notes:

- White railroad stop bars should be placed prior to the railroad warning devices and at the approach to the traffic signal when road conditions support these applications.
- Where there are no gates, just flashers or railroad cross buck signs, it should be noted why gates are not recommended by the HRSE. (i.e. lower train speeds, geometric issues, funding issues with the crossing being a lower priority than others, etc.) If upgrades are supported, these are to be fully discussed at the field meeting.
- As the funding for any traffic signal and/or railroad warning device often comes from different sources, the priorities have to be evaluated within the confines of available program funding. It is important to document the sources of funding and meet the priority needs defined for various areas. This type of coordination is needed by the LADOTD's Railroad Safety Unit to assist in their statewide program. The fiscal limits may cause other recommendations to be considered or documented.
- A 2 conductor, #14 AWG stranded wire shall be used for railroad interconnect.

3.4.2 Bridge Preemption Guidance

The following information should be considered standard for all bridge preemption projects.

The phase preemption sequence is determined by the bridge approach. The phase corresponding to the bridge approach shall be the first phase of the sequence. All subsequent phases will service movements in an efficient and safe manner and not direct traffic onto the bridge. Once preemption has been completed, all movements not previously serviced shall be serviced in an efficient and safe manner. Designers shall verify the bridge preemption sequence with the DTOE.

All signal projects that include bridge preemption should state how much extra wiring will be needed to be included at the Type E junction box to reach the bridge system.

Install one 24 DC relay in the signal cabinet. The relay is energized in absence of bridge preemption calls and is de-energized when bridge preemption calls are present. The relay is activated by the control desk switch that controls the bridge flashers. The bridge control house provides a normally closed contact connection.

A # 14 two conductor wire will be ran in a minimum 1 inch HDPE conduit between the traffic signal cabinet to the designated terminal blocks inside either the bridge control house or the main bridge junction box where spare terminal blocks are available. Six feet of spare wire is required when a connection is made at the junction box. Fifth-teen feet of spare wire is required when a connection is made inside the bridge control house.

Designers shall verify connection locations with LADOTD's Bridge Electrical Section.

3.5 ADVANCED TRAFFIC MANAGEMENT SYSTEM (ATMS)

LADOTD utilizes an Advanced Traffic Management System (ATMS) for the management of traffic signals across the state. LADOTD’s current ATMS is the Trafficware ATMS.now, please see the operations manual for detailed software operations. The ATMS is used to store the timing data for LADOTD traffic signals that use a Trafficware Controller. The ATMS can also provide real time information for all signals that have communication to the ATMS server. This section will state LADOTD’s policy for the ATMS. The DTOE for a District should be contacted for procedures the individual District may have that exceeds what is stated within this section.

3.5.1 Signal Timings

Signal timings are to be updated in LADOTD’s ATMS whenever there has been a change. The previously active timings are to be stored within the ATMS incase there is a need to revert the timings and for historic records. All changes to signal timing databases are to be confirmed by the DTOE or a designated individual prior to the ATMS “permanent” signal timing database.

Any changes to signal timings due to emergencies shall require the approval of the DTOE prior to those changes being put into effect.

3.5.2 Signal Alarms

The ATMS provides alarms for those signals that have continuous communication to the ATMS Server. Alarms are to be checked each morning and monitored during normal business hours. During non-business hours the appropriate Traffic Management Center should contact a District’s designated non-business hours personnel for alarms designated as critical. A list of critical alarms is provided in Table 3-2 – Critical Alarm Tier Table. The contacted personnel will be responsible for informing the DTOE or designated personnel by DTOE so that proper responses are taken based on the type of alarm. An alarm should be investigated within 24 hours once notification is received by the District.

Alarm	Alarm Tier
Power Up Alarm	Critical (if battery backup present)
Stop Timing	Critical
Cabinet Door Open	Critical
Local Flash Input	Critical
MMU Flash Input	Critical
CMU Fault	Critical
Controller Fault	Critical
MMU SDLC Failure	Critical
Critical SDLC Failure	Critical
EEPROM CRC Fault	Critical
Monitor/ Flash Alarm delay	Critical
EEPROM Compare Fault	Critical

Table 3-2 – Critical Alarm Tier Table

Alarm	Alarm Tier
Cabinet Door Activation	Non-critical
Coordination Failure	Non-critical
Closed Loop Disabled	Non-critical
Manual Control Enable.	Non-critical
Coordination Free Switch Input	Non-critical
Cycle Fault	Non-critical
Cycle Failure	Non-critical
Coordination Fault	Non-critical
Detector SDLC Failure	Non-critical
SDLC Response Frame Fault	Non-critical
Detector Diagnostic Failure	Non-critical
Detector Failure From SDLC	Non-critical
Queue Detector Alarm	Non-critical
Ped Detector Failure	Non-critical
Pattern Error	Non-critical
Time Download Requested from Field	Non-critical
Lamp Failure - Ch B	Non-critical
Lamp Failure - Ch A	Non-critical
Database Download Requested from Field	Non-critical
Pattern Active	Non-critical
TS2 Delinquent Error	Non-critical
FIO Delinquent Error	Non-critical
Temp Alert #1	Non-critical
Temp Alert #2	Non-critical
Coord Diagnostic Fail	Non-critical
Controller Access	Non-critical
Coordination Active	Non-critical
Preempt Active	Non-critical
Coordination Failure	Non-critical
Coord in Transition	Non-critical
LRT Alarm Rail Check	Non-critical
TSP Active Trigger	Non-critical
LRT - Detector Stuck	Non-critical
LRT - Check In/Out Sequence Error	Non-critical
LRT - Check In Arrival Time Failure	Non-critical
LRT - Check Out Arrival Time Failure	Non-critical
SIU SDLC Error	Non-critical
SIU SDLC Fault	Non-critical
CMU SDLC Fault	Non-critical

Figure 3 – Non-Critical Alarm Tier Table

4 SIGNAL EQUIPMENT AND SIGNS

4.1 GENERAL EQUIPMENT AND SIGN INFORMATION

All signal equipment and signs to be installed at a signalized intersection shall be new. The reuse of existing signal equipment is not allowed. This applies to all signal upgrades and modifications, but not to signal maintenance.

In the case that replacing signal equipment disrupts uniformity at a signalized intersection all related signal equipment shall be replaced also. A designer should refer to the LADOTD Traffic Signal Standard Plans when doing any design work. If a signal design requires a special design that is not covered by the LADOTD Traffic Signal Standard Plans than the designer is to provided the proposed design to the Traffic Engineering Section for review and approval.

4.2 VEHICLE DETECTORS

4.2.1 General

Vehicle detectors are used to detect the presence or passage of a vehicle on a portion of a roadway. They are an integral part of any traffic actuated signal design as their input determines the variable timing and phasing of the signal. Additionally, the proper placement of these detectors contributes significantly to the overall efficiency of the traffic operations at the intersection.

LADOTD uses varies vehicle detector technologies. A designer shall confirm with the District Traffic Operations Engineer what technologies are to be installed at a signal. A list of available technologies LADOTD is using may be found on the LADOTD Traffic Signal Tool Box List.

4.2.2 Detector Card/Channel Assignments

The following detector card assignments shall be used for typical applications.

- **Pole Mounted Cabinet**

- (Type 3E, 4 Phase)

- 4 Cards

- Card 1 – Loops Detection

- Card 2 – Video Detection

- Card 3 – Peds

- Card 4 – Preemption

- **Ground Mounted Cabinet**
 - (Type 6E, 8 Phase)
 - 6 Cards
 - Cards 1 & 2 – Loops Detection
 - Card 3 – Video Detection
 - Card 4 – Overlaps
 - Cards 5 & 6 – Peds and Preemption

4.2.3 Detection Types

a. Stop Bar Detection

Stop bar detection is located at or near the stop bar on an intersection approach, to detect the presence of stopped vehicles and operate in the “presence (non-locking)” mode of detection. Accordingly, stop bar detection is used in through lanes on minor approaches and in left turn lanes on both major and minor approaches. They can screen out right turns made on red or left turns made on left turn permitted signal phases, preventing false calls. Consideration should also be given to installing stop bar detectors in left turn lanes on major approaches that are not protected with a left turn arrow. Such detectors can hold the green phase while the left turn vehicle waits for possible gaps in opposing traffic.

b. Volume Density Detectors

Advance detectors are used with volume density control and are located some distance in advance of the approach stop line. They are located in the through lanes of the major street. These detectors operate in the “pulse (locking)” mode and detect the passage of a vehicle. Advance detectors can provide the controller with advance information on vehicles approaching the intersection and, in the case of a volume density controller, can count the number of vehicles on the approach that are waiting with a red signal indication. The location of these detectors is based on the safe stopping distance of approaching vehicles, which varies according to the approach speed.

In order to use video cameras for advance detection, special permission would be required. A cost estimate will also be needed for the installation of video cameras, such as installation cost, pole cost (if a pole is needed), wiring, video camera components, etc.

Also, permission must be obtained by LADOTD’s Bridge Design Section to run wiring for detection along all bridges.

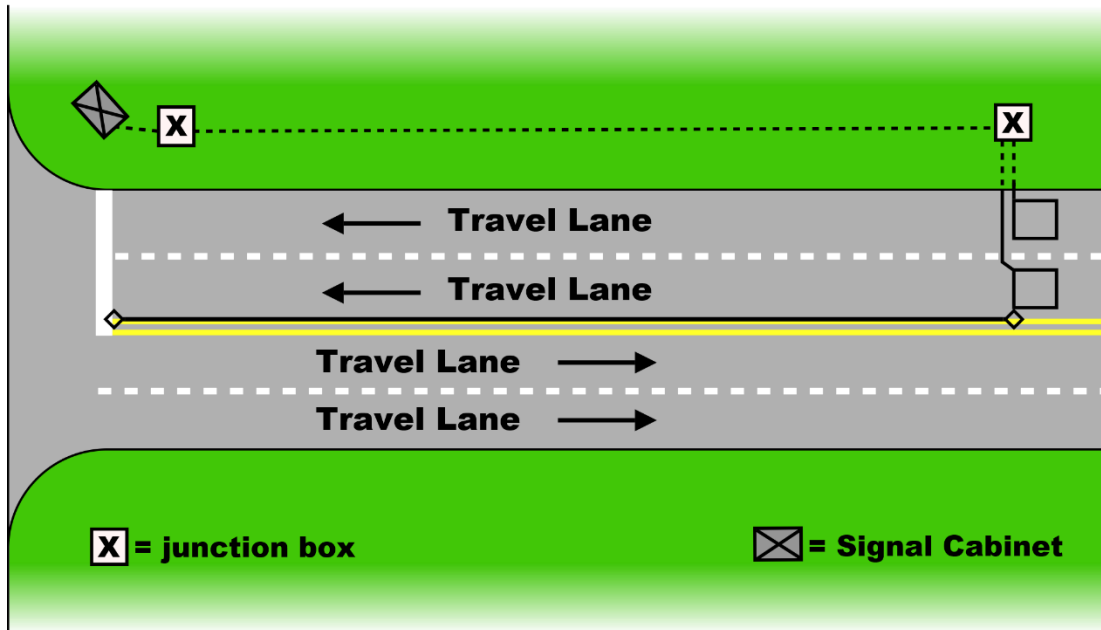

Note: 1) Pulse {Locking Memory} Mode of Detection

2) Detector setback {X} based on safe stopping
Distance formula {See Table Below}

$$X = SSD = rV + \frac{0.5 V^2}{d}$$

Where: r = Reaction time = 1.0 sec
V = Approach Speed (ft/sec)
D = Deceleration rate = 10 ft/sec²

Approach Speed (mph)	X (Detector Setback) (ft)
30	141
35	183
40	231
45	284
50	342
55	406
60	475
65	549

Figure 4-1 Volume Density Loop Placement

c. Queue Detectors

Queue detectors are a type of detection that are available to the designer in special cases. An example of a common application is freeway off-ramps where long queues may cause a safety concern. The designer must decide how the queue detector is to be implemented. One method would be to locate a 6' X 6' loop at a selected location on the ramp. The detector should have some amount of delay to ensure that vehicles are queued (5 – 10 seconds depending on location.) The input of the queue detector could be assigned to preempt. The preempt sequence should be programmed to provide the desired change in signal operation.

4.2.4 Detector Types²⁸

See the ITE Traffic Engineering Handbook for information on the different detector types.

²⁸ Traffic Engineering Handbook, 6th ed., 2009, p. 441 – p. 443

4.3 SIGNAL HEADS

Signal heads shall adhere to those standards set forth in the MUTCD. The LADOTD application of those standards is as follows:

4.3.1 Lens Size

Twelve (12) inch diameter lenses are required on all LADOTD signal heads regardless of their distance beyond the stop line.

4.3.2 Light Source

LEDs shall be used.

4.3.3 Back Plates

Signal back plates shall be used on all heads installed on mast arms. Back plates shall have a dull black finish and be outlined with a retro reflective yellow rectangle. When back plates are used on a span wire, a tether may be required; a special detail is required to be included in the construction plans when back plates are used on span wire.

4.3.4 Number of Signal Faces²⁹

- One overhead signal face per lane.
- A minimum of two signal faces for the major movement on each approach.
- If the signal faces are more than 180 ft. beyond the stop line, a supplemental near side signal face is required.

4.3.5 Positioning

a. Horizontal Placement

See MUTCD Section 4D.13.

b. Vertical Placement

The placement of the signal head over the roadway shall provide a 17 foot minimum vertical clearance from the bottom of the signal head to the roadway. On routes designated by LADOTD as large load routes signal head height should be increased. See MUTCD Section 4D.14 and MUTCD Section 4D.15.

4.3.6 Face Arrangement

Vertical rather than horizontal signal face arrangements are preferred for LADOTD signal installations. Side by side signal indications are allowed in cluster arrangements. In order to best determine what signal head types are required for an intersection the designer should know the signal phasing prior to determining signal heads.

²⁹ MUTCD, 2009, Part 4, p. 459, Section 4D.11

4.3.7 Left Turn Signals

a. Three Section Heads

Three section left turn heads are used for a “protected only” left turn operation, and if a separate left turn lane exists. Three section left turn heads are also used where dual left turns exist, at the top of some “T” intersections, and one-way street approaches.

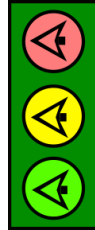

b. Three Section Heads (Flashing Yellow Arrow)

Three section flashing yellow arrow heads are to be used where a designated left turn lane is present and a “permitted only” operation is used. When using a flashing yellow arrow head special consideration should be taken due to the LADOTD’s standard for the head connections within the signal cabinet. A designer should view the LADOTD Traffic Signal Standard Plans for connection details. (Currently only 4 FYA signal heads can be installed per intersection due to hardware limitations.)



c. Four Section Heads (Non-Flashing Yellow Arrow)

Four section left turn heads are used where the left turn is part of a split phase operation, at the top of some “T” intersections and one-way street approaches.

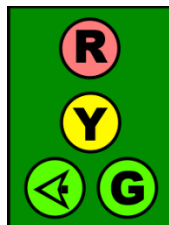

d. Four Section Heads (Flashing Yellow Arrow)

Four section flashing yellow arrow left turn heads are used where a designated left turn lane is present and “protected/permitted” operations are used. When

using a flashing yellow arrow head special consideration should be taken due to the LADOTD's standard for the head connections within the signal cabinet. A designer should view the LADOTD Traffic Signal Standard Plans for connection details. (Currently only 4 FYA signal heads can be installed per intersection due to hardware limitations.)



e. Five Section Heads

Five section left turn signal heads are used only when a designated left turn lane is not present and where the left turn operation is “protected/permited.”

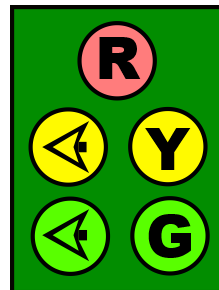

4.3.8 Right Turn Signals

Right turn signals are normally provided only where there is a separate right turn lane accompanied by a right turn signal overlap with a compatible cross street left turn signal phase.

a. Three Section Protected Only Heads

Three section right turn heads are at the top of some “T” intersections and exclusive right-hand turn lanes.

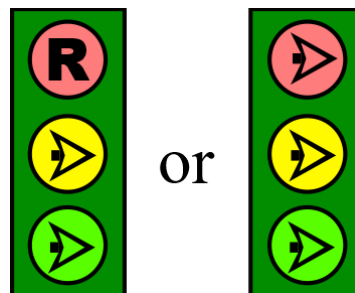

b. Three Section Permitted Only Heads (Flashing Yellow Arrow)

Three section permitted only flashing yellow arrow right turn heads are used where a designated right turn lane is not adjacent to a through lane and operates as controlled “permitted” right. When using a flashing yellow arrow head special consideration should be taken due to the LADOTD’s standard for the head connections within the signal cabinet. A designer should view the LADOTD Traffic Signal Standard Plans for connection details. See MUTCD 4D.24 p.480. (Currently only 4 FYA signal heads can be installed per intersection due to hardware limitations.)

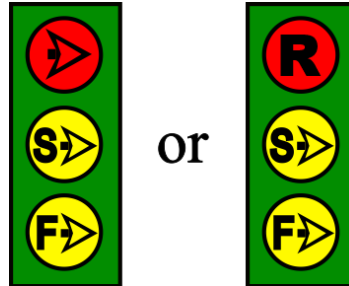

c. Four Section Heads (Flashing Yellow Arrow)

Four section flashing yellow arrow right turn heads are used where a designated right turn lane is not adjacent to a through lane and operates as controlled “protected/permitted” right. When using a flashing yellow arrow head special consideration should be taken due to the LADOTD’s standard for the head connections within the signal cabinet. A designer should view the LADOTD Traffic Signal Standard Plans for connection details. See MUTCD 4D.24 p.480. (Currently only 4 FYA signal heads can be installed per intersection due to hardware limitations.)



d. Five Section Heads

Five section right turn heads are used at 4-way intersections and typically requires overlap phasing. May be used at “T” intersections where there are pedestrian movements protected by pedestrian signal indications. In addition, they may be used for exclusive right-hand turn lanes adjacent to a through lane.

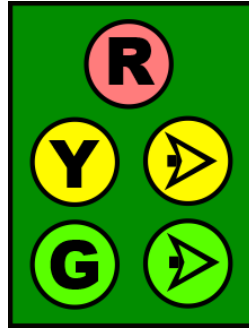

4.3.9 Pedestrian Signal Indications

- a. The bottom of its housing shall be located 7-10 feet above the sidewalk.
- b. Pedestrian signal heads are to be count down signal heads.
- c. LADOTD uses only the 9-inch-high symbols, both the Upraised Hand and Walking Person.
- d. For information on the placement of pedestrian push buttons see the MUTCD Chapter 4 Section 4E.08 (Pedestrian Detectors). Each push button is to be supplemented by sign R10-3a, R10-3b, R10-3c, R10-3d or R10-3e. Use of signs shall be as defined in the MUTCD.

4.3.10 Visibilities and Shielding

- a. All signal indications should be equipped with cut away (partial) visors.
- b. Use full tunnel visors with louvers or programmed visibility lenses where signal indications are visible and simultaneously display different colors from conflicting movement approaches.
- c. Use programmed visibility lenses on the far signals where signals are closely spaced and simultaneously display conflicting color indications to approaching motorists.
- d. Use either programmed visibility lenses or full tunnel visors with louvers on the signals where the intersection of two roadways is less than 90 degrees causing conflicting signal indications on one street to be seen by motorists on the other street.

4.4 TRAFFIC SIGNAL CONTROLLERS/ CABINETS/COMMUNICATION

4.4.1 Signal Controllers

The standard controller at all new signalized intersections shall be an 8-phase, NEMA controller that meets current LADOTD standards and specifications. An 8-phase controller is to be specified even at “T” intersections to facilitate controller interchangeability and to simplify LADOTD’s controller inventory.

4.4.2 Controller Cabinets

a. Cabinet Types

- LADOTD Type 3E – Pole mounted cabinets
- LADOTD Type 6E – Ground mounted cabinets

b. Interconnection and Cabinets

- LADOTD Type 6E cabinets shall be used in interconnected systems.

c. Orientation

The controller cabinet shall be oriented so that the traffic personnel will be facing the intersection while looking in the cabinet.

d. Location

Controller cabinets should be located as far as practical off the edge of the roadway and in the same intersection quadrant as the power source. Do not locate the cabinet in the median or where traffic personnel will be standing in a ditch.

e. Cabinet Access

All traffic signal cabinets are to be installed with concrete pads. When cabinets are not installed at ground level or there are issues related to cabinet access, the pads shall be installed with steps to provide access to the cabinet so that the signal controller will be in a 5ft to 5.5ft range from the top step/platform. See the LADOTD Traffic Signal Standard Plans for additional information related to the signal cabinet foundation design.

4.4.3 **Communication**

Communication is the interconnection of signals to form a system. The system may be either isolated or connected to the LADOTD network. The intent of inter-signal communications is to allow for data exchange related to coordination, video and other signal related information.

a. Interconnect/Communications

i. Modems

1. When a fiber optic cable is used for signal coordination, a fiber optic interface modem is needed in each coordinated signal cabinet.
2. When a 7-conductor cable is used for signal coordination, a hard wire relay panel is needed instead of a modem.

ii. Master to TMC/District Office

1. Required at all closed loop systems.
2. Depending on location communications may be:
 - Fiber Optics
 - Phone Drop
 - Wireless

4.4.4 **Coordination Without Communications**

When communication is not possible but coordination is required the use of time based coordination should be used. To accomplish time based coordination a GPS is required to ensure that time is kept correctly.

4.5 POWER SUPPLY

An electrical service source shall be designated on signal plans and TSIs.

4.5.1 Location

The electrical service should be in the same quadrant as the signal cabinet. If the power source is more than 20 feet from the controller cabinet, a signal service pedestal with circuit breaker shall be supplied adjacent to the controller cabinet.

4.5.2 Quantity

In quantity calculations, the term “electrical service” or “power supply” includes the pole, circuit breaker, ground rod, conduit (riser) and conductors on the utility company’s pole and/or conduit (riser) and conductor on the service pole. A separate 2” conduit (riser) must be provided where the power is brought down a pole which does not have a circuit breaker.

4.5.3 Luminaires

Where street lights are permitted on LADOTD signal poles, they shall have their own circuit breaker on the service pole and the power conductor routing shall not pass through the controller cabinet. A City/State Maintenance Agreement shall be obtain for maintenance of the luminaires. Luminaires are only mounted if a full signal maintenance agreement exists.

4.5.4 Conduit

Wherever a power supply cable is run underground, it shall be in its own separate 2” Ø conduit.

4.6 SIGNAL SUPPORTS

Signal supports which include both steel strain poles and mast arm poles shall be in accordance with LADOTD specifications. Refer to EDSM IV.7.1.5 (Traffic Signal and Flashing Beacon Installation and Maintenance) on mast arm use. Adjacent utility poles shall not be used for signal supports in new installations unless limited physical conditions preclude the installation of separate signal supports. Engineering judgment must be exercised in determining the proper signal support system for the intersection. The following guidelines are provided to aid in that determination.

During design process a designer shall take into account all visible utilities. Visible utilities should be avoided and measurements are to be taken. In circumstances where utilities and signal supports conflict and the support location cannot be modified the designer is to follow the procedures for utility relocation.

4.6.1 Mast Arms

Mast Arms are LADOTD's preferred form of traffic signal support. Where used on LADOTD signal installations, mast arms shall be in accordance with current LADOTD Traffic Signal Standard Plans. Refer to EDSM IV.7.1.5 (Traffic Signal and Flashing Beacon Installation and Maintenance) on mast arm use.

- **Advantages:**³⁰

- **Rigid Mount** - Mast arms provide a more rigid mounting for signal heads and overhead signs than do span wire installations. Accordingly, they are particularly applicable where programmed visibility signal heads are used. They also require less maintenance in regards to turned signal heads and turned over head signs.
- **Backplates** - Mast arms allows for the installation of backplates for signal heads without additional hardware and maintenance.
- **Aesthetics** - Mast arm installations are more aesthetically pleasing than span wire installations since there is no overhead span wire or signal wiring.

- **Disadvantages:**

- **Costs** - Mast arms are more expensive than strain poles.³¹
- **Jack and Boring** - Jacking and boring under the roadway is required to get signal and detector cables to the signal controller.

³⁰ Traffic Engineering Handbook, 2009, p. 437

³¹ Traffic Engineering Handbook, 2009, p. 438

a. Mast Arm Arrangements

Typical mast arm arrangements are shown in Figure 4-2 through Figure 4-5. See LADOTD Traffic Signal Standard Plans for mast arm length restrictions. In circumstances where LADOTD's standard poles are restricted a signed and stamped design for a special foundation may be required. All special foundation designs requires approval by Traffic Services prior to use.

i. Single Mast Arm

A typical single mast arm installation is shown in Figure 4-2 where it is used at the intersection of two undivided roadways.

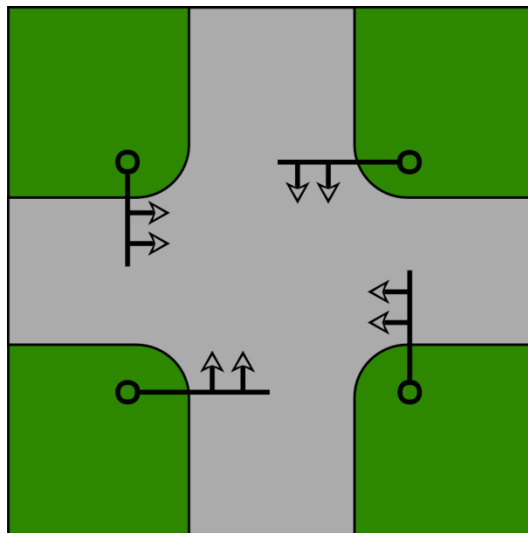

Figure 4-2 Mast Arm Arrangements: Single Mast Arm

- **Advantages:**
 - Provides the required minimum 40 feet distance between the signal heads and the stop line of all approaches.
 - Provides good far side signal visibility for pedestrians.
 - Provides locations for pedestrian signals and pedestrian detectors where needed.
- **Disadvantages:**
 - Requires four mast arm poles and foundations.

ii. Dual Mast Arms

Where one of the two intersecting roadways has a curbed median with a width of at least 8 feet, a dual mast arm arrangement can be used as shown below. The dual mast arm arrangement is also applicable at offset intersections as shown in Figure 4-3 and at “T” intersections as shown in Figure 4-5.

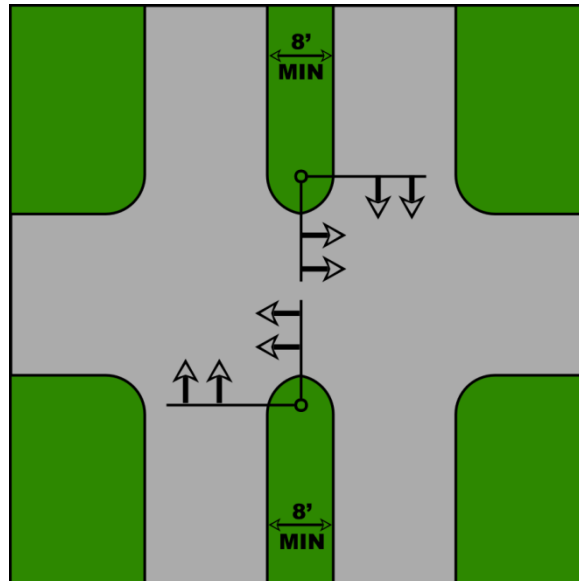

Figure 4-3 Mast Arm Arrangements: Dual Mast Arm with Curbed Median

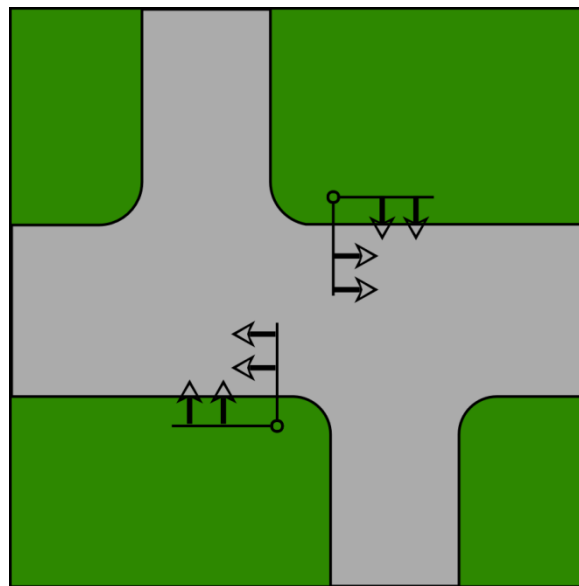

Figure 4-4 Mast Arm Arrangement: Dual Mast Arm

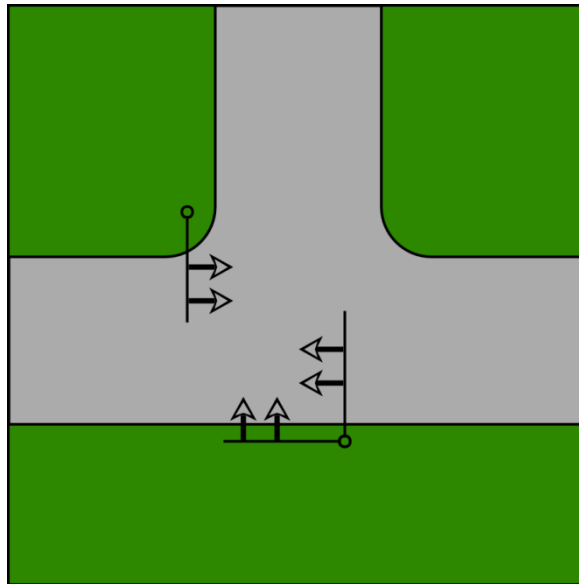

Figure 4-5 Mast Arm Arrangements: Combinations Single and Dual Mast Arms

▪ **Advantages:**

- Uses two less mast arm poles than a single mast arm arrangement.
- In the divided roadway application, it provides a closer placement of signal heads on the street without the median.
- Provides good signal placement for offset intersections.

▪ **Disadvantages:**

- In the divided roadway application, it places mast arm poles on median area where they are more likely to be struck by vehicles.
- In the divided roadway application, additional signal poles may be needed if pedestrian signals and detectors are required.
- In the divided roadway application, pedestrians cannot see the parallel signal indications once they get to the median area.

b. Mast Arm Length

Mast arm length must be specified on signal plan sheets. The arm length is determined by taking into account signal head placement in relation to the approach travel lanes and the pole setback off the edge of the travel way. The mast arm length shall not exceed the maximum length available in LADOTD's master items list for construction. It should be noted that a special foundation and/or pole design may be required.

c. Suggested Mast Arm Pole Location

A designer should review the LADOTD Traffic Signal Standard Plans for additional mast arm information when determining suggested proposed locations. Final locations will be determined in the field.

i. Minimum Roadway Clearances (Horizontal)

Mast arms should be located as far as practical off the edge of the roadway while staying within the right-of-way. Mast arms locations should also be placed where they will not adversely be affecting signal visibility.

ii. Median Placement

Mast arms should not be located on medians whose widths are less than 8 feet; if the signals have to be located in a median such as this, vertical face curbing shall be installed.

iii. Locations

- Mast arms should be located so that signals installed on the mast arm are located between 40 to 180 feet from the approach stop line.
- Mast arms should consider over height truck movement to allow the truck to weave around the arms.

d. Luminaires

Street lights are permitted on LADOTD mast arm poles provided that they are to be designed integral with the pole and they are to have a minimum mounting height of 30 feet above the roadway. A City/State Maintenance Agreement shall be obtained for maintenance of the luminaires. Luminaires are only mounted if a full signal maintenance agreement exists.

e. Decorative Poles

If any other pole/pole design other than as defined as a LADOTD's standard pole is used, a memorandum of understanding (MOU) is required along with 2 spare poles or a full signal maintenance agreement.

4.6.2 Strain Poles

Strain poles may be applicable where a mast arm installation would require mast arms in excess of 70 ft. in length and there is no geometric way to add a location for a mast arm.

a. Maximum Span Length

The placement of the strain poles shall be such as to limit the span wire length to a maximum of 90 ft or less from the first signal head per Traffic Signal Standards Plans.

b. Span Wire Arrangements

Span wire arrangements in general allow for further pole setbacks from the roadway than do mast arms installations. In addition, they eliminate the need for jacking and boring under the roadway by allowing signal and detector cables to be run overhead on the signal span wire.³² Diagonal spans are not allowed. The following are the LADOTD approved span wire arrangements. If backplates are installed a tether is required due to wind forces.

³² Traffic Engineering Handbook, 2009, p. 439

i. Box Span

This signal arrangement places strain poles on each of the four corners of the intersection. (See Figure 4-6)

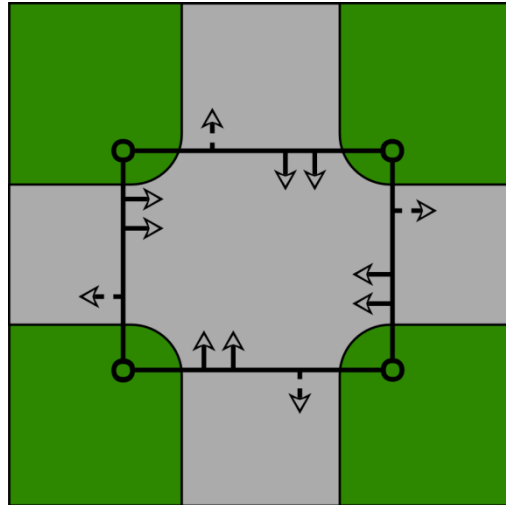

Figure 4-6 Span Wire Arrangement: Box Span

- **Advantages:**³³
 - Allows good alignment of signal heads and span wire mounted signs.
 - Provides the required minimum 40 feet distance between the signal heads and stop line on all approaches.
 - Provides lower span wire lengths, loading and sag than diagonal spans.
 - Provides locations for pedestrian signals and pedestrian detectors when needed.
- **Disadvantages:**³⁴
 - Requires 4 poles
 - Could require supplemental signal heads if the signal heads are beyond 180 feet beyond the approach stop line.

³³ Traffic Engineering Handbook, 2009, p. 441

³⁴ Traffic Engineering Handbook, 2009, p. 441

ii. Z Spans

Z span installation may be applicable on divided roadways where medians are at least 8 feet wide. Z spans are also applicable at offset intersections.

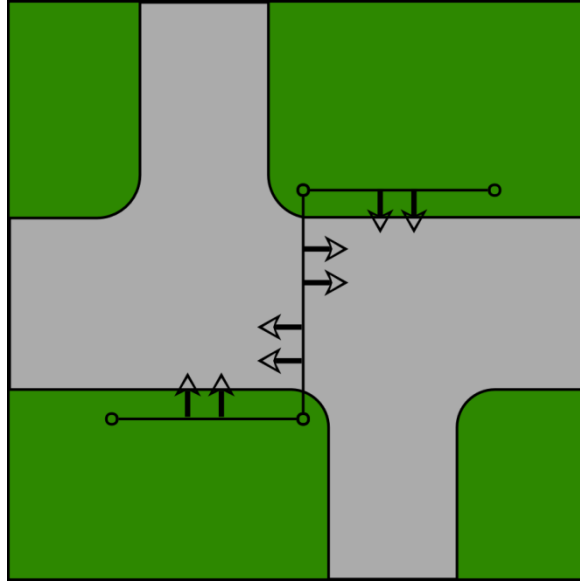

Figure 4-7 - Span Wire Arrangement: Z Span

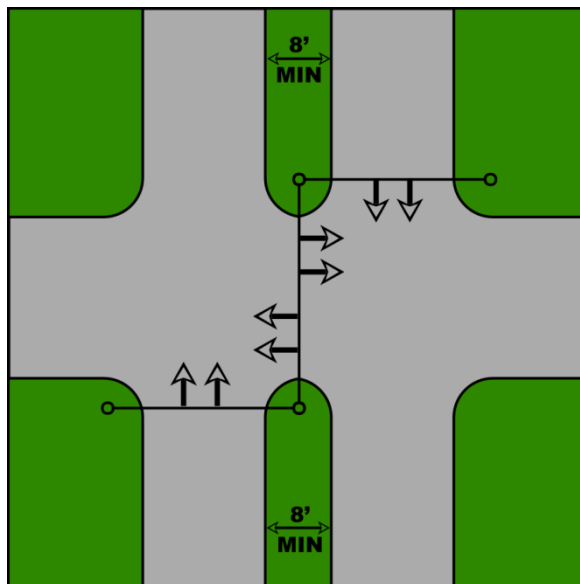

Figure 4-8 Span Wire Arrangement: Z Span with Curbed Median

- **Advantages:**³⁵
 - On divided roadways, shorter span wires are required across the street with the median.
 - On divided roadways, a closer placement of signal heads for the street without the median is possible.
 - Provides good signal placement for offset intersections.
- **Disadvantages:**³⁶
 - On divided roadways, it places signal poles in median areas where they are more likely to be struck by vehicles.
 - On divided roadways, additional signal poles may be needed if pedestrian signals and detectors are required.
 - On divided roadways, pedestrians cannot see the parallel signal indications once they get to the median area.

iii. U-Span

This arrangement has good application at T intersections.

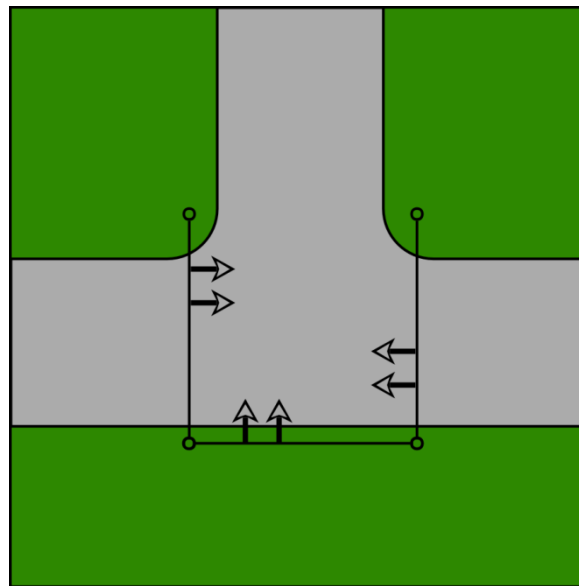

Figure 4-9 Span Wire Arrangement: U-Span

- **Advantages:**
 - Allows good alignment of signal heads and span wire mounted signs.
 - Poles are available for pedestrian signal heads and detectors if needed.
 - Good visibility of signal indicators for pedestrians.

³⁵ Traffic Engineering Handbook, 2009, p. 441

³⁶ Traffic Engineering Handbook, 2009, p. 441

- Provides shorter span wire lengths and less loading and sag than the diagonal spans.

- **Disadvantages:**

- Four poles are required.

c. Pole Base

All LADOTD steel strain poles shall have a “shoe” type base.³⁷

d. Pole Height Determination

The height of a strain pole is determined by the equation shown in the most recent LADOTD Traffic Signal Standard Plans.

e. Pole Location

i. Minimum Roadway Clearances (Horizontal)

Strain poles should be located as far as practical off the edge of the roadway while staying within the right-of-way and keeping the span wire length under the design restrictions in the LADOTD Traffic Signal Standard Plans. In any case, signal poles should be located as far as practical from the edge of travel lane without adversely affecting signal visibility.

ii. Median Placement

Strain poles should not be located on medians whose widths are less than 8 feet; if the signals have to be located in a median such as this, vertical face curbing shall be installed.

iii. Signal Location

Strain poles should be located so that signals hung on their span wire are located between 40 to 180 feet from the approach stop line.

f. Luminaires

Where street lights are permitted on LADOTD strain poles they are to be designed integral with the pole and mounted at a minimum height of 30 ft. above the roadway. A Full Maintenance Agreement shall be obtained for maintenance of the luminaires. Luminaires are only mounted if a full signal maintenance agreement exists.

³⁷ LADOTD, Traffic Services and Installation Detail Standard Plans, sheet 217

4.7 SIGNAL WIRING

After the signal head and signal detector arrangements/placements have been determined, the signal wiring required involves the following steps:

4.7.1 Signal Device Requirement

Determine the wiring requirement of each individual signal device by using Figure 4-10.

4.7.2 Mast Arm/Span Wire Runs

Determine the wiring required for the signal heads depending on whether span wire or mast arms are used. Figure 4-18 through Figure 4-28 show typical wiring requirements for a wide variety of signal head arrangements on span wires and mast arms respectively.

4.7.3 Detectors/Power/Interconnect Cable

Determine the wiring required for detectors, power, and interconnect cables where applicable using Figure 4-10.

4.7.4 Sizing Conduit











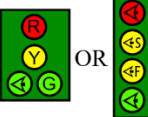

Combine the wiring requirements in Sections 4.7.2 and 4.7.3 above and size the conduit needed for each wiring run using Figure 4-11.

4.7.5 Signal Wiring Examples

Figure 4-12 through Figure 4-17 contains the following example:

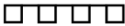
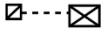
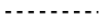
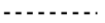
- Basic Span Wire Signal Wiring
- Basic Mast Arm Wiring
- Basic Conduit Wiring
- Full Intersection Diagram
- Full Signal Wiring
- Full Signal Wiring Table

TRAFFIC SIGNAL DEVICE WIRING REQUIREMENTS

DEVICE	REQUIRED CONDUCTORS AND TYPE
	3 SECTION HEAD 1 - 6c (#14 AWG STRANDED)
	3 SECTION TURN SIGNAL HEAD 1 - 10c (#14 AWG STRANDED)
	4 SECTION TURN SIGNAL HEAD 1 - 10c (#14 AWG STRANDED)
	5 SECTION TURN SIGNAL HEAD 1 - 10c (#14 AWG STRANDED)
	PEDESTRIAN SIGNAL HEAD 1 - 6c (#14 AWG STRANDED)
	PEDESTRIAN PUSH BUTTON 1 - 2c (#14 AWG STRANDED AND SHIELDED)
	EMERGENCY VEHICLE PREEMPTION DETECTOR 1 - 3c (EC) (VARIES WITH MANUFACTURER)
	TRAFFIC SIGNAL POWER SUPPLY 1 - 3c (POWER) (#6 AWG CONCENTRIC - VARIES WITH RUN DISTANCE))
	STREET LIGHT 1 - 2c (SL) (#6 AWG)
	LOOP DETECTOR WIRE 1 - 1c (LOOP WIRE) (IMSA 51-7 #14 AWG WITH 19 STRANDED. INSULATION SHALL BE 0.035 XLPE WITH POLYETHYLENE LOOSE TUBE.)
	LOOP LEAD IN (HOME RUN) (1 PER PHASE) 1 - 2c (#14 AWG STRANDED AND SHIELDED.)
	INTERCONNECT CABLE 1 - 7c (#12 AWG)
	INTERCONNECT CABLE (TWISTED PAIR) 1 - 6PR (TWISTED PAIR) (IMSA 20-6 #19 AWG SOLID)
	INTERCONNECT CABLE (FIBER OPTIC CABLE) 1 - FOC (FIBER OPTIC CABLE) (VARIES BY APPLICATION)
	RAILROAD INTERCONNECT 1 - 2c (#14 AWG STRANDED)
	INTERNALLY ILLUMINATED SIGN 1 - 3c (#14 AWG STRANDED)
	BLANK OUT SIGN 1 - 3c (#14 AWG STRANDED)

SOURCE: LADOTD TRAFFIC SERVICES SECTION AND LOUISIANA STANDARD SPECIFICATIONS FOR ROADS AND BRIDGES.

Figure 4-10 Traffic Signal Device Wiring Requirements Diagram

Conductor Size (Area - in²)

# OF COND.	2C STREET LIGHT	2C #14 LOOP LEAD IN	2C PED PUSH BUTTON	3C #6 POWER	3C INT. ILL SIGNS	3C EMER. COND.	VIDEO CABLE	6C #14 SIGNAL	6 PR. INTER CONN.	10C #14 SIGNAL	# OF COND.
1	0.5	0.096	0.096	0.750	0.105	0.071	0.206	0.167	0.388	0.292	1
2	1.0	0.192	0.192		0.210	0.142	0.412	0.334		0.584	2
3	1.5	0.288	0.288		0.315	0.213	0.618	0.501		0.876	3
4	2.0	0.384	0.384		0.420	0.284	0.824	0.668		1.168	4
5	2.5	0.480	0.480		0.525	0.355	1.030	0.835		1.460	5
6	3.0	0.576	0.576		0.630	0.426	1.236	1.002		1.752	6
7	3.5	0.672	0.672		0.735	0.497	1.442	1.169		2.044	7
8	4.0	0.768	0.768		0.840	0.568	1.648	1.336		2.336	8
9	4.5	0.864	0.864		0.945	0.639	1.854	1.503		2.628	9
10	5.0	0.960	0.960		1.050	0.710	2.060	1.670		2.920	10
11	5.5	1.056	1.056		1.155	0.781	2.266	1.837		3.212	11
12	6.0	1.152	1.152		1.260	0.852	2.472	2.004		3.504	12
13	6.5	1.248	1.248		1.365	0.923	2.678	2.171		3.796	13
14	7.0	1.344	1.344		1.470	0.994	2.884	2.338		4.088	14
15	7.5	1.440	1.440		1.575	1.065	3.090	2.505		4.380	15

Conduit Capacity (SCH. 80 PEC)	
Conduit Diameter	MAX. Conduit Capacity (40% Filled)
1"	0.278 in ²
2"	1.160 in ²
3"	2.590 in ²

Notes:

A) Table Abbreviations:

- COND. - Conductor
- PED. - Pedestrian
- INT. ILL. - Internally Illuminated
- EMGR. COND. - Emergency Conductors
- PR. INTER CONN. - Pair Interconnect

B) Standard conduit sizes normally specified for the following uses:

- 1) 1/2" Diameter - For each vehicle detector curb penetration (For Loop Wire)
- 2) 2" Diameter - For loop lead in (Home Run) (For up to 2-2c)
- 3) 2" Diameter - For interconnect line (for 1-6pr or fiber optics line)
- 4) 2" Diameter - For power feed (For 1-3c)
- 5) 3" Diameter - For wire runs from mast arm or cabinet foundation to nearest junction box.

C) General Conduit Sizing Procedure:

- 1) To determine conduit size needed for a particular combination of conductors, determine the area of all conductors in the run using the above table.
- 2) Compare to the conduit capacity section to determine the conduit size and number required. Note that only a 40% conduit capacity is allowed. This will allow for voids between conductors and easier conductor pulling in the conduit.

Figure 4-11 Traffic Signal Conduit Sizing

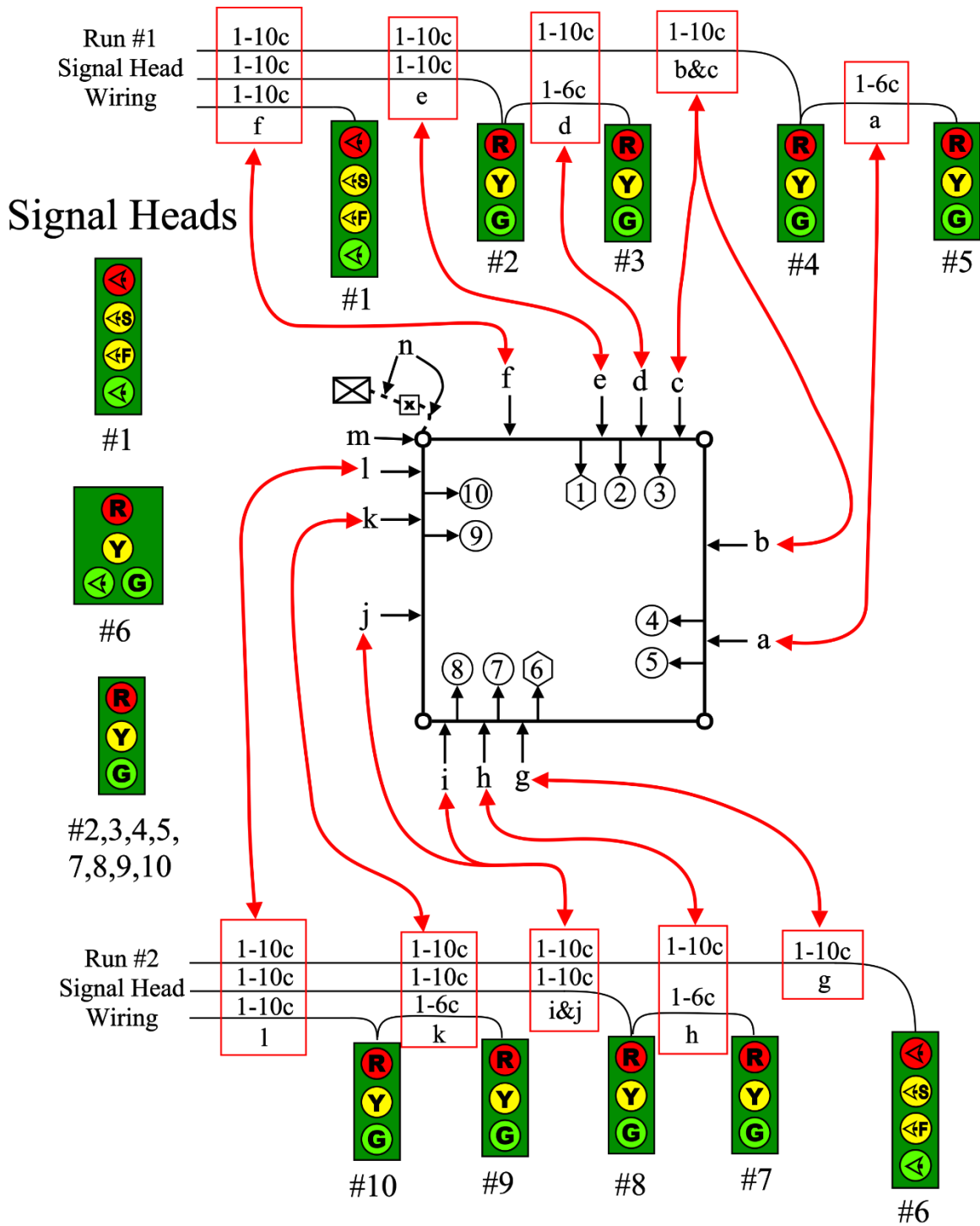

Figure 4-12 Basic Span Wire Signal Wiring

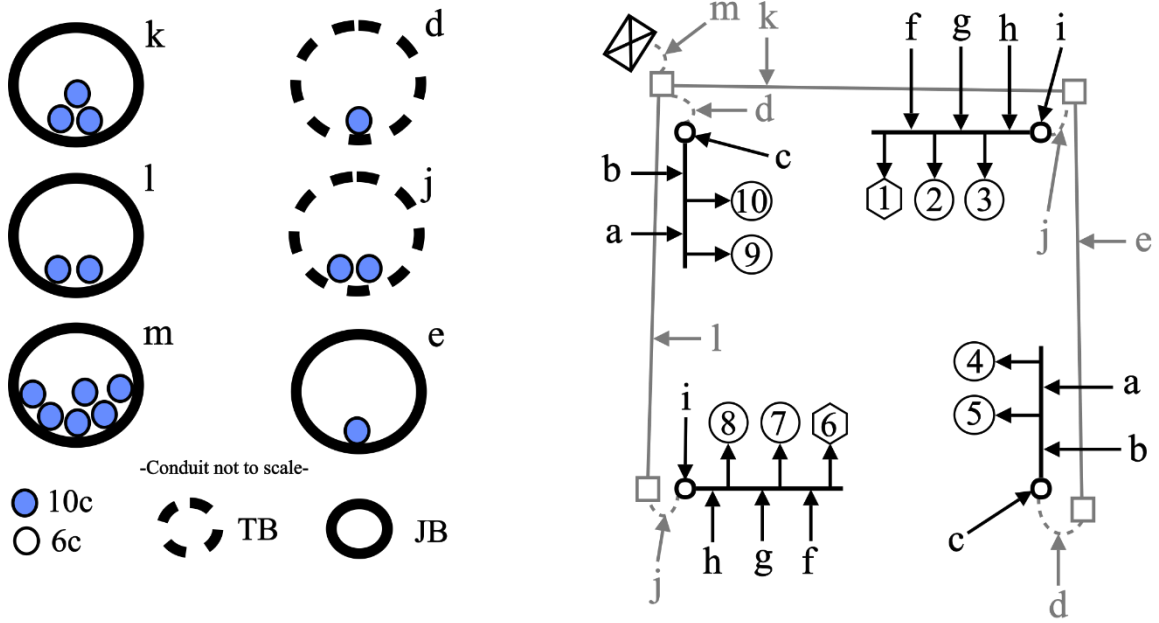

Figure 4-14 Basic Conduit Wiring

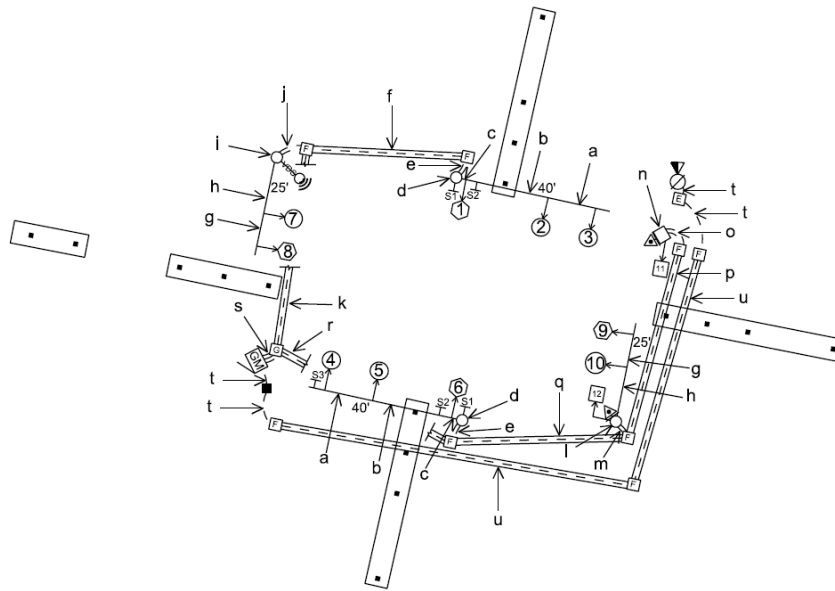

Figure 4-16 Full Signal Wiring Diagram

SIGNAL WIRING TABLE														TYPE		
WIRING CODE	WIRING TYPE						INTERCONNECT			CONDUIT						
	VIDEO	LOOP	2CLL	2C	MAG	3C POWER	3C	6C	10C	7C	Wireless	6 PAIR	FIBER	NO.	SIZE	
a								1								OH
b								2								OH
c								2	1							OH
d								2	1							IP
e									2					2	3"	TB
f									2					1	3"	JB
g									1							OH
h								1	1							OH
i					1			1	1							IP
j					1			1	1					2	3"	TB
k					1			1	3					1	3"	JB
l				1				2	1							IP
m				1				2	1					2	3"	TB
n				1				1								IP
o				1				1						2	3"	TB
p				1				1						1	3"	JB
q				2				3	1					1	3"	JB
r				2				3	3					1	3"	JB
s				2	1			4	6					3	3"	TB
t						1								1	2"	TB
u						1								1	3"	JB

OH - OVERHEAD JB - JACK OR BORE TB - TRENCH AND BACKFILL SC - SAW CUT IP - INSIDE POLE
 WIRING CODE TABLE VERSION 3.2

Figure 4-17 Full Signal Wiring Table

TYPICAL SPANWIRE SIGNAL WIRING

NOTES:

- 1.) WIRE TERMINATION TAKES PLACE AT SIGNAL HEADS.
- 2.) LEFT TURN AND RIGHT TURN HEADS WIRED SEPARATELY

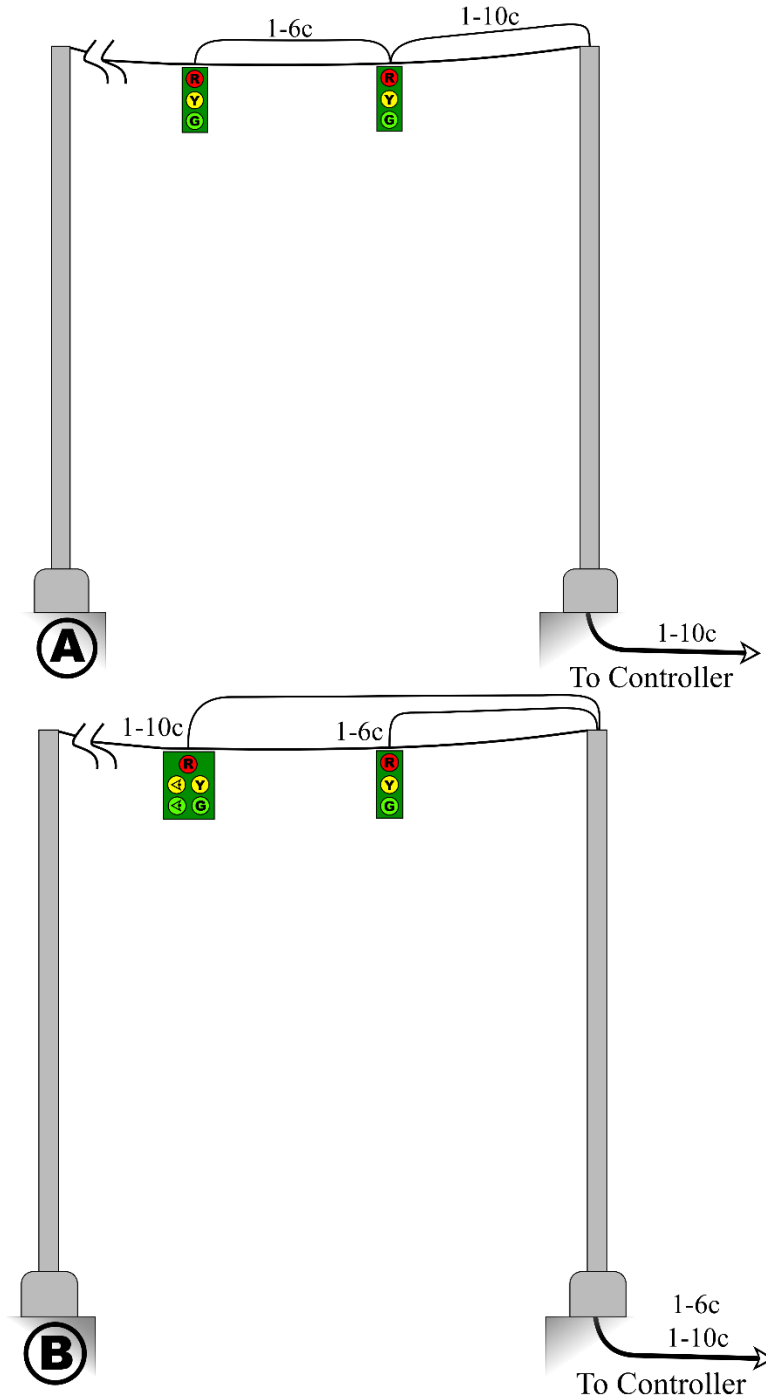

Figure 4-18 Typical Span Wire Signal Wiring: Examples A & B

- NOTES:
 1.) WIRE TERMINATION TAKES PLACE AT SIGNAL HEADS.
 2.) LEFT TURN AND RIGHT TURN HEADS WIRED SEPARATELY

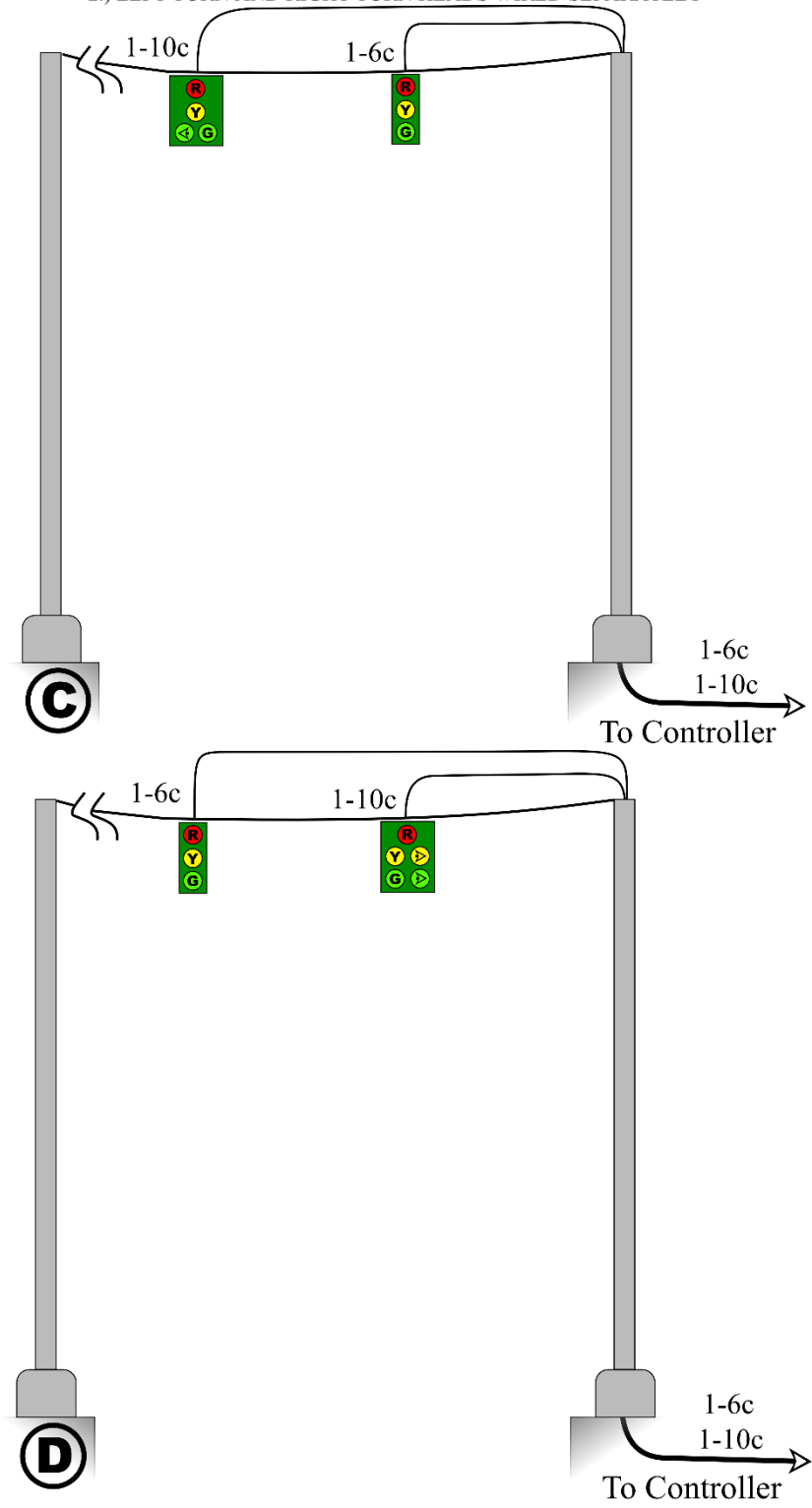

Figure 4-19 Typical Span Wire Signal Wiring: Examples C & D

- NOTES:
 1.) WIRE TERMINATION TAKES PLACE AT SIGNAL HEADS.
 2.) LEFT TURN AND RIGHT TURN HEADS WIRED SEPARATELY

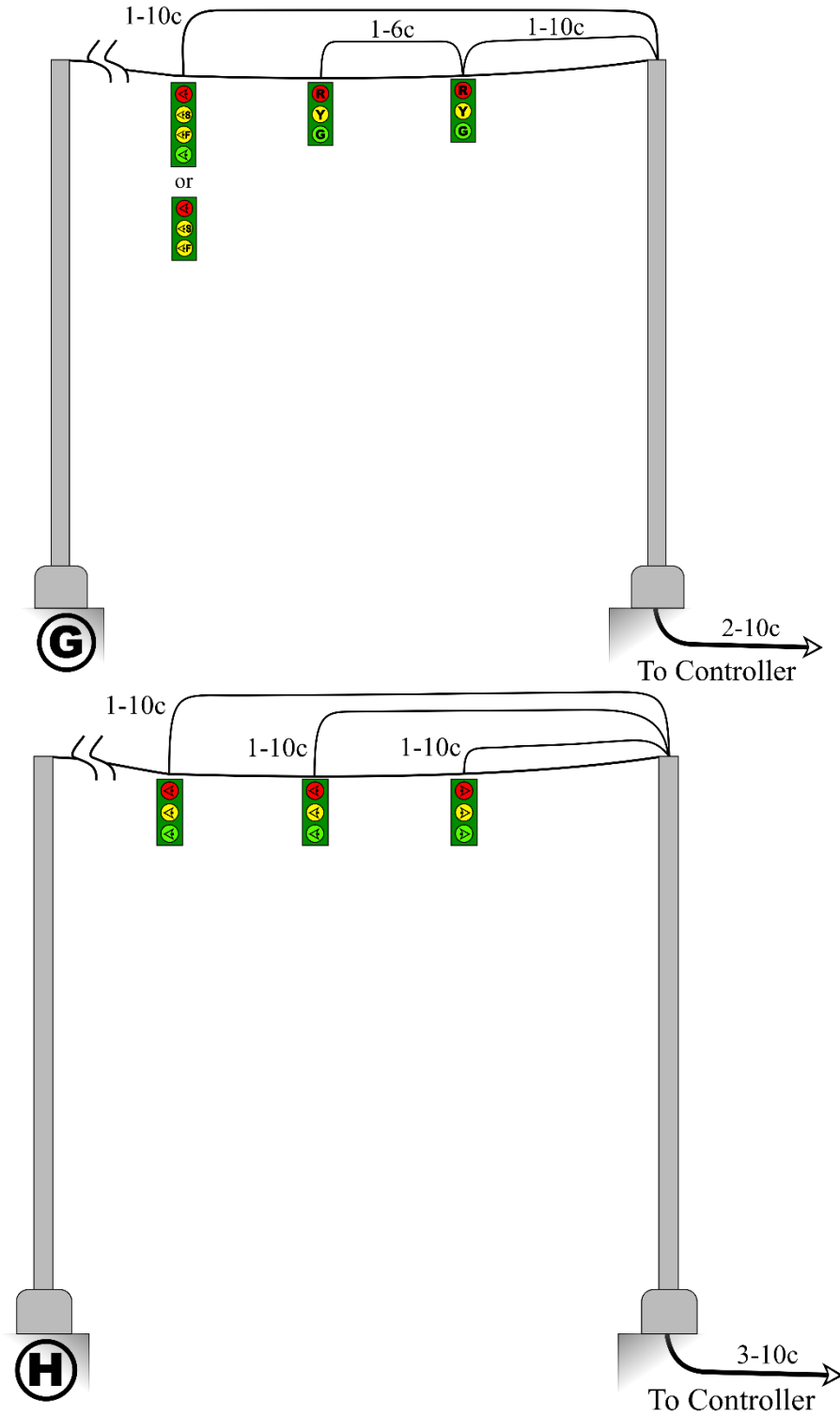

Figure 4-21 Typical Span Wire Signal Wiring: Examples G & H

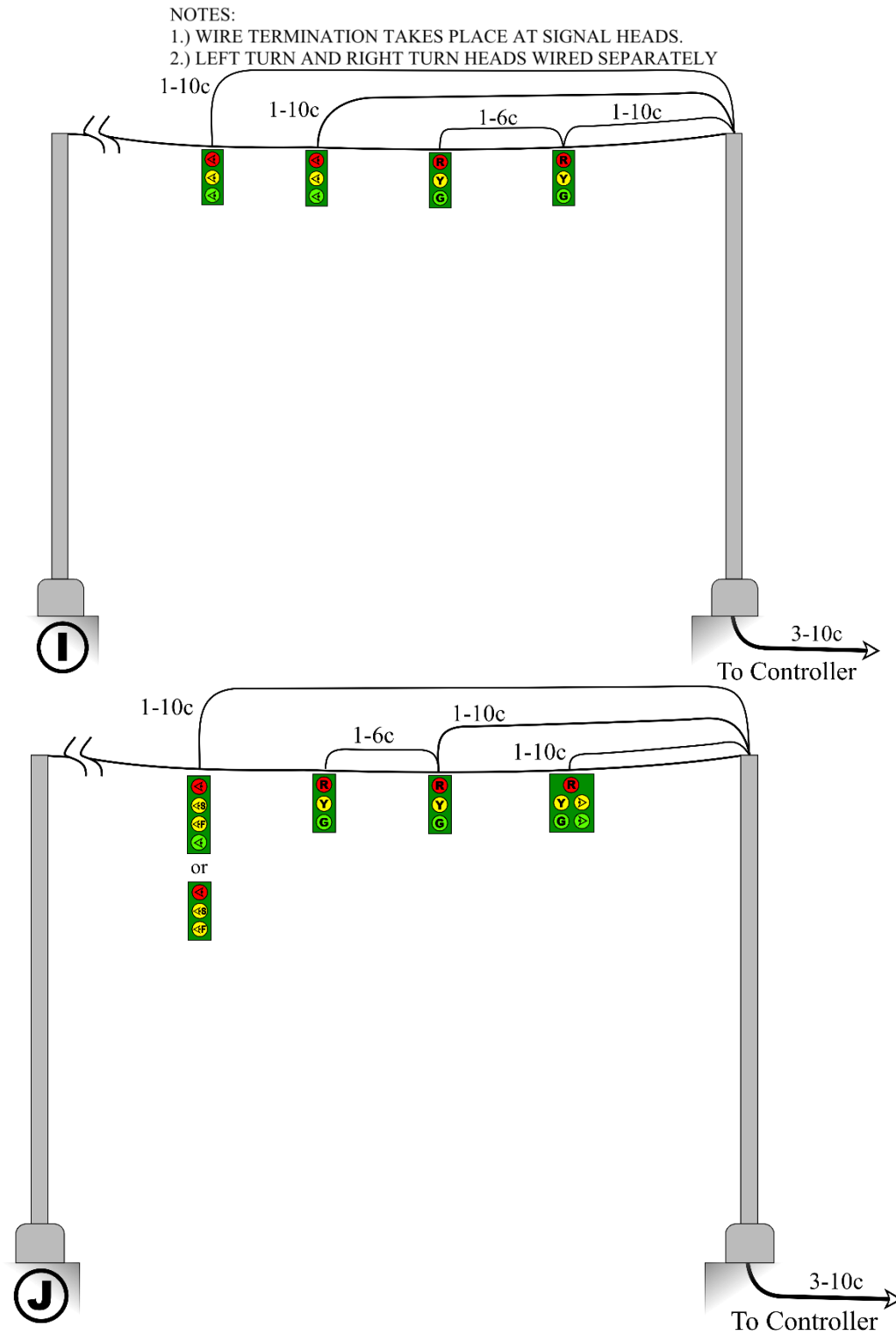

Figure 4-22 Typical Span Wire Signal Wiring: Examples I & J

- NOTES:
 1.) WIRE TERMINATION TAKES PLACE AT SIGNAL HEADS.
 2.) LEFT TURN AND RIGHT TURN HEADS WIRED SEPARATELY

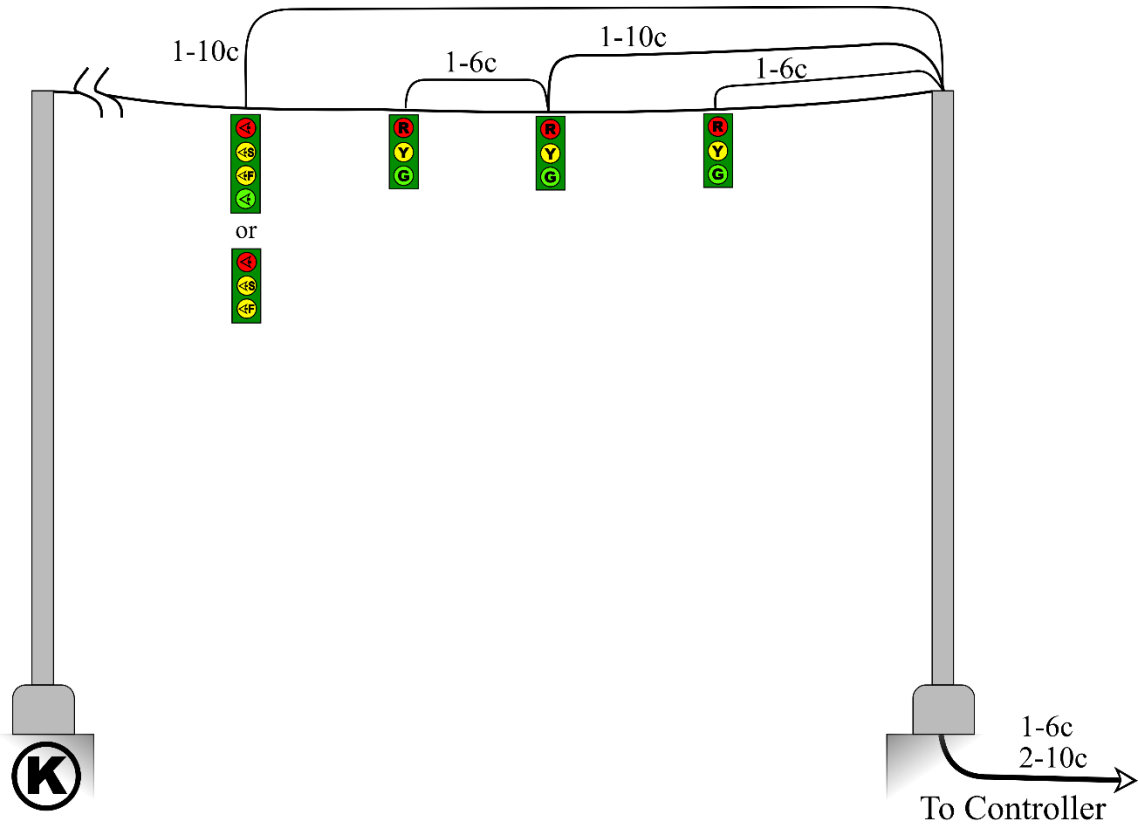

Figure 4-23 Typical Span Wire Signal Wiring: Example K

TYPICAL MAST ARM SIGNAL WIRING

- NOTES:
1.) WIRE TERMINATION TAKES PLACE AT SIGNAL HEADS.
2.) LEFT TURN AND RIGHT TURN HEADS WIRED SEPARATELY

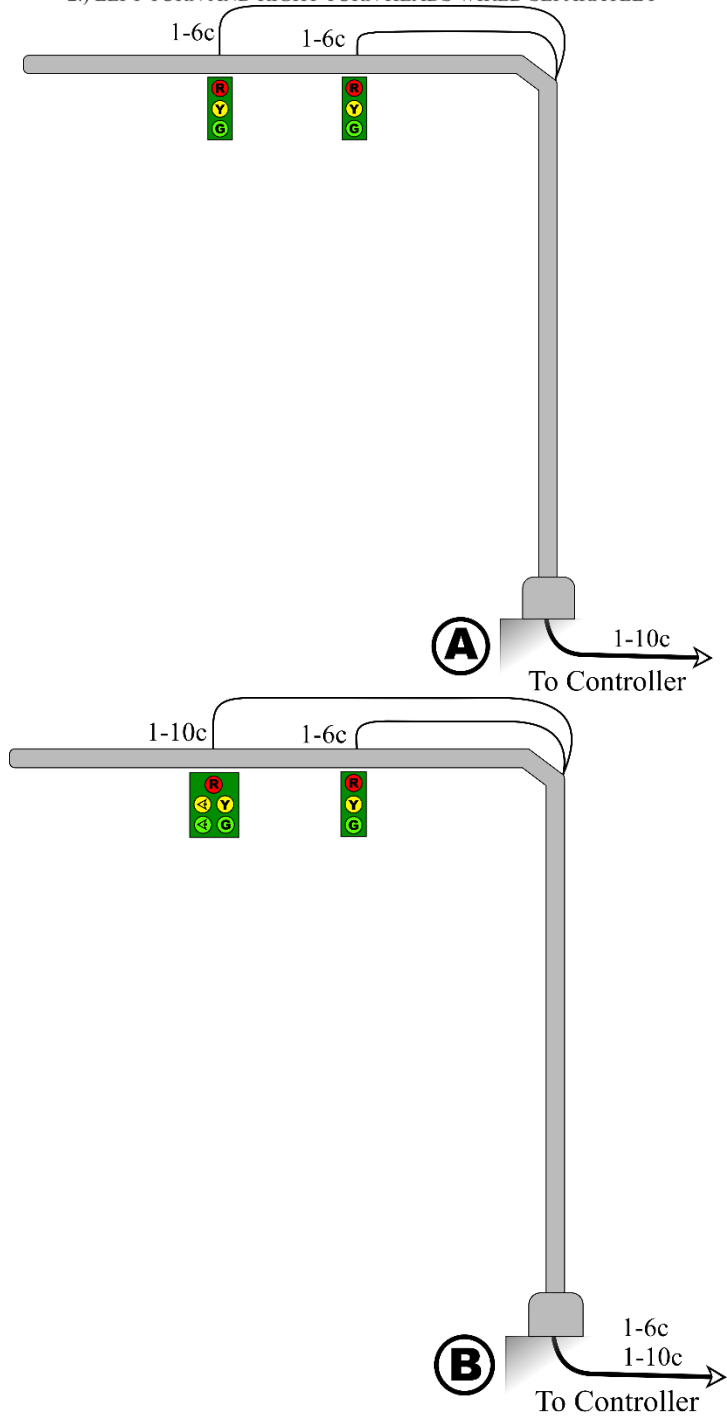

Figure 4-24 Typical Mast Arm Signal Wiring: Examples A & B

NOTES:
 1.) WIRE TERMINATION TAKES PLACE AT SIGNAL HEADS.
 2.) LEFT TURN AND RIGHT TURN HEADS WIRED SEPARATELY

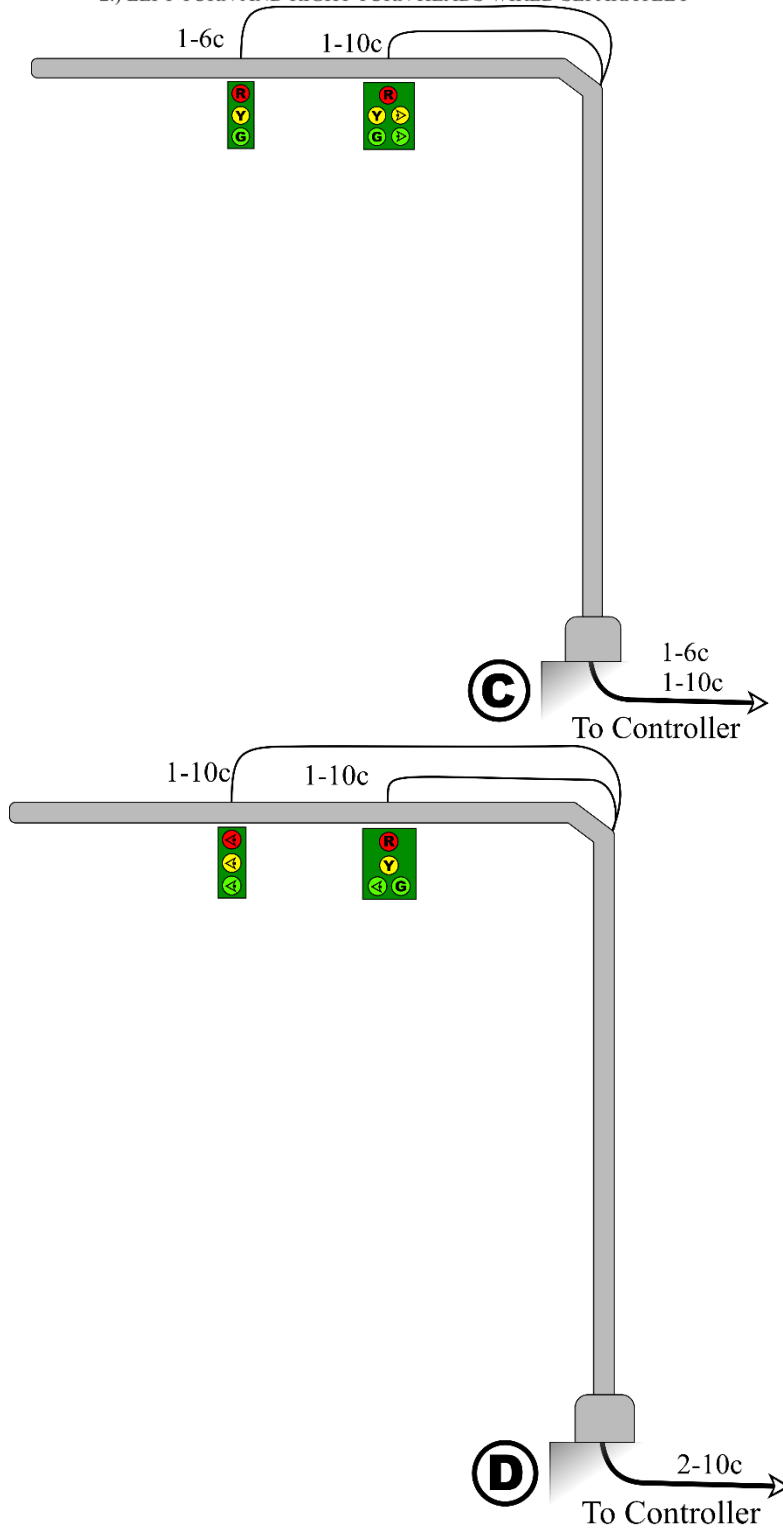

Figure 4-25 Typical Mast Arm Signal Wiring: Examples C & D

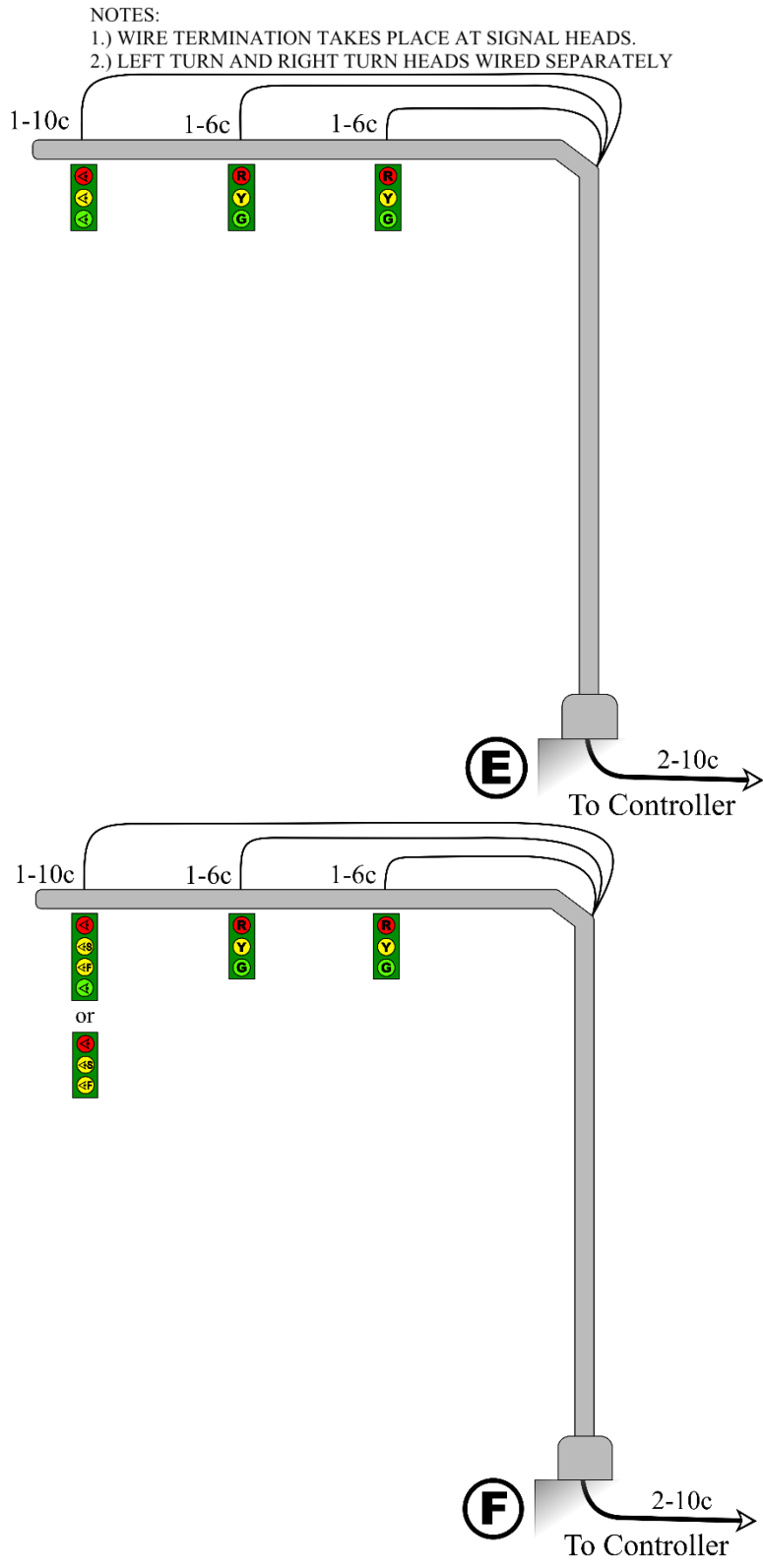

Figure 4-26 Typical Mast Arm Signal Wiring: Examples E & F

NOTES:
 1.) WIRE TERMINATION TAKES PLACE AT SIGNAL HEADS.
 2.) LEFT TURN AND RIGHT TURN HEADS WIRED SEPARATELY

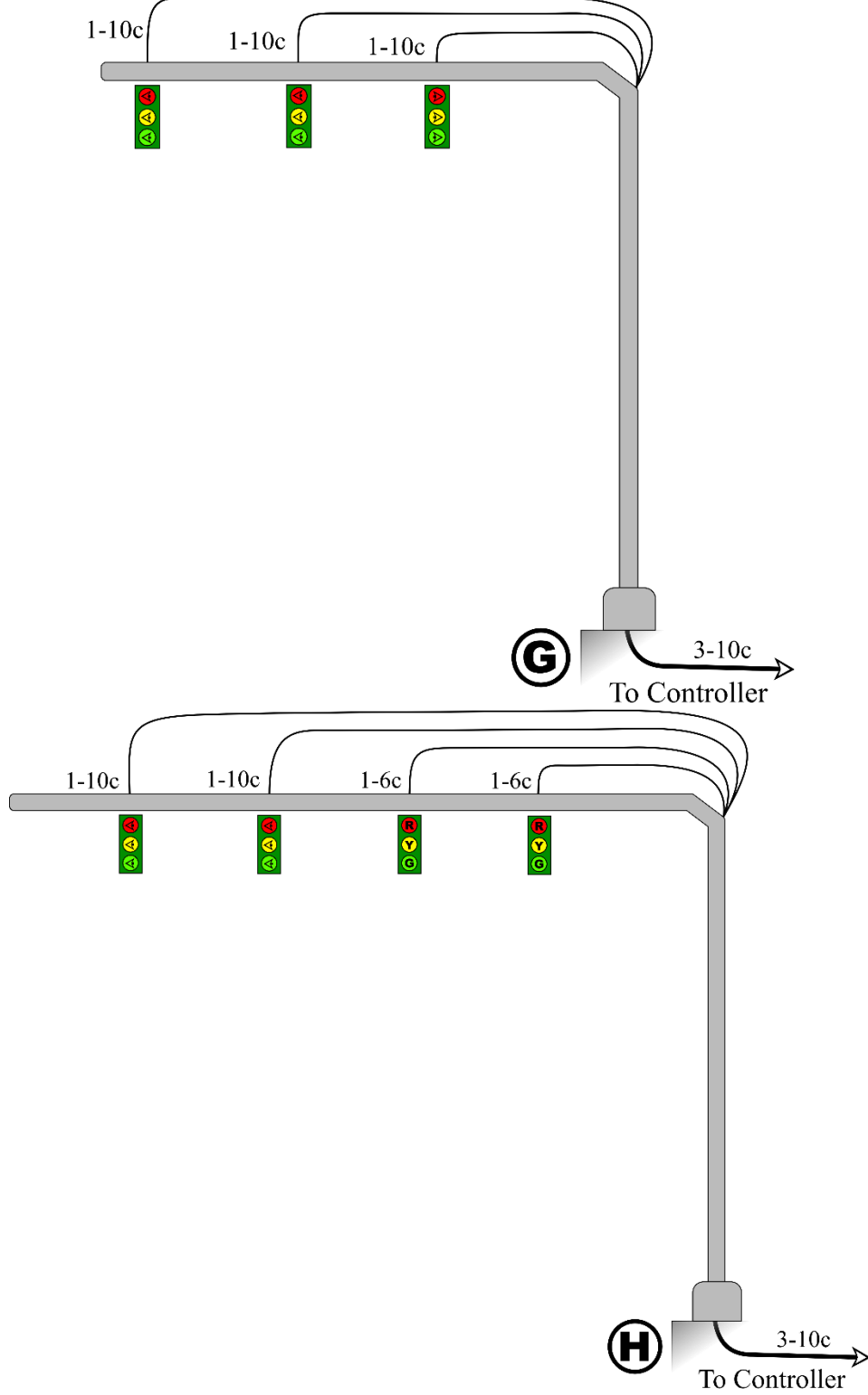

Figure 4-27 Typical Mast Arm Signal Wiring: Examples G & H

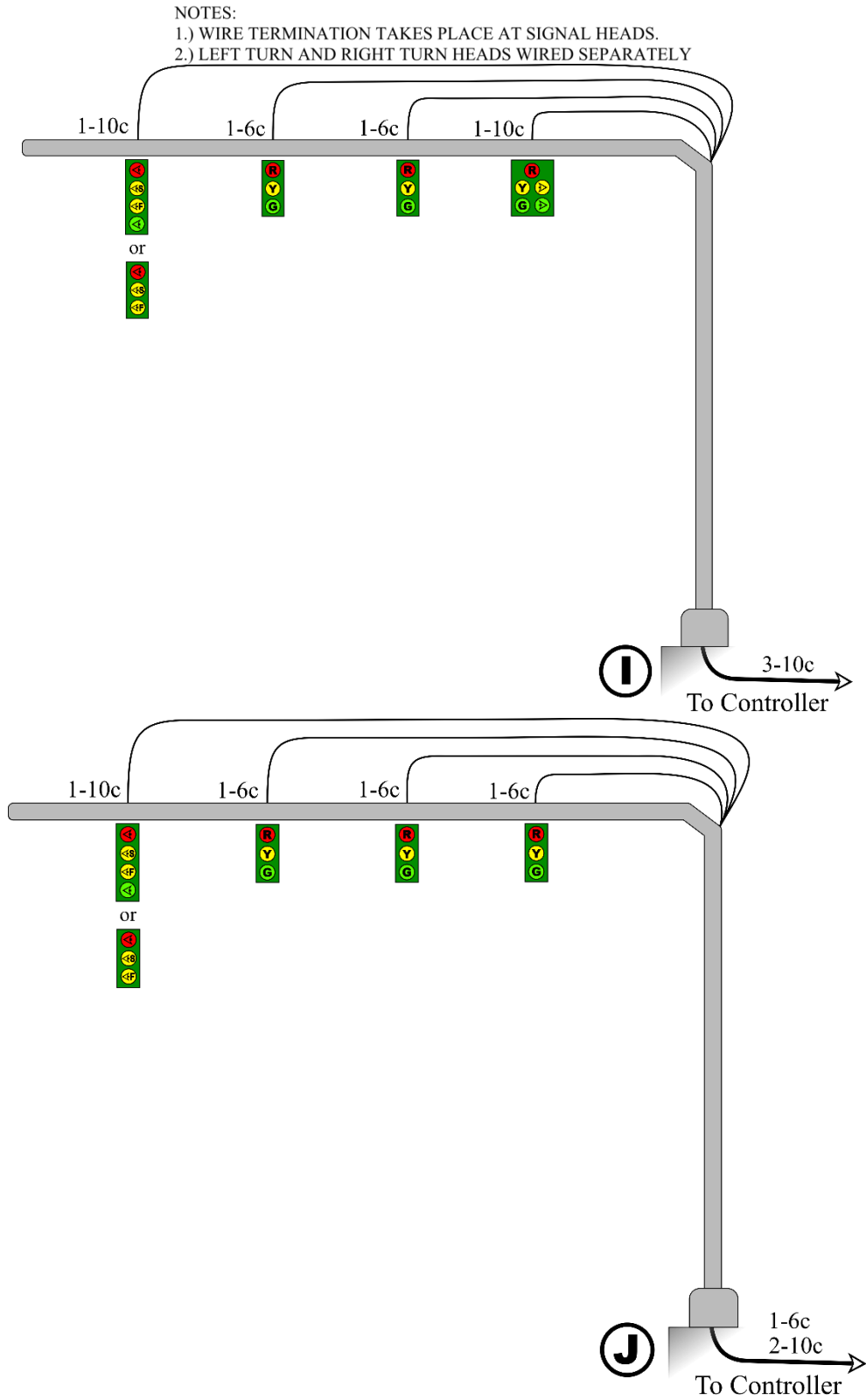

Figure 4-28 Typical Mast Arm Signal Wiring: Examples I & J

4.8 CONDUIT

Conduit used for traffic signal installation shall have the following characteristics:

4.8.1 Material Type

- Underground: PEC (Polyethylene Conduit), Schedule 80
- Above ground: RIGID

4.8.2 Depth Installed (Underground)

See the current LADOTD Traffic Signal Standard Plans for depth.

4.8.3 Sizing

The maximum size conduit to be used on LADOTD signal installations shall be three (3) inch diameter. Where larger conduit capacity is required, multiple conduit runs will be used. The sizing of conduit shall be such as to not fill over 40% internal area of the conduit. (See Figure 4-11)

4.8.4 Jack and Boring

Where jacking and boring of conduit is required to cross an intersection, the most efficient and least obstructed route should be used.

4.8.5 Spare Conduit

A spare conduit shall be included from each foundation to its corresponding junction box.

4.9 JUNCTION BOXES

Junction boxes used in LADOTD signal installations shall meet current LADOTD standard specifications.

4.9.1 Purpose

- To provide access to underground detectors and interconnect cables.
- To provide locations to consolidated separate runs of signal and detector cables.
- To provide locations to facilitate the pulling of long runs of detector or interconnect cables.
- To provide locations to store spare lengths of signal detector or interconnect cables.

4.9.2 Type/Size/Use

Table 4-1 Junction Boxes shows the various size junction boxes and their normal application or use.

Type	Cover Size (AxB)(inches)	Box Size (CxDxE)	Common Uses (*These boxes must contain only detector wiring.)
E	23.75x13.75	25x15.5x12	1. Intermediate locations along detector home runs. 2. Along 6 pair interconnect runs. 3. At curb penetrations for vehicle detectors.*
F	30.5x17.5	32.25x19.25x12	At both ends of jacking and boring locations.
G	35.625x24	37.625x26x18	At controller cabinet location, to consolidate all wiring before entering the controller cabinet base.
H	35.625x24	37.625x26x36	For fiber optic runs.

Table 4-1 Junction Boxes

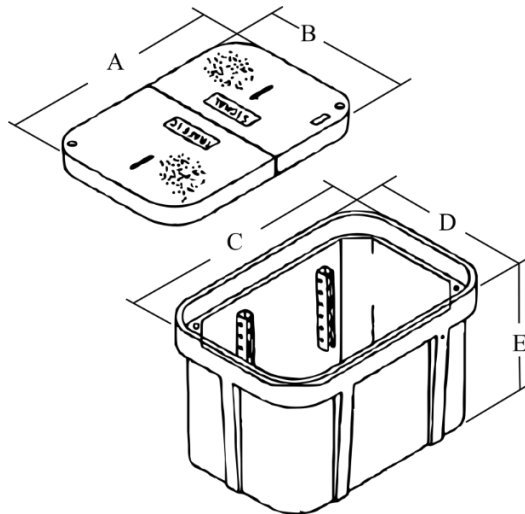

4.9.3 Spacing

The maximum spacing for junction boxes according to use is as follows:

- Signal and detector runs – 500 ft.
- Interconnect runs – 1000 ft.

4.9.4 Material

Junction boxes are to be of heavy-duty design in according with LADOTD standards.

4.10 SIGNS

Traffic control signs at or in advance of signalized intersections shall be installed as follows:

4.10.1 Span Wire/Mast Arm (Overhead) Mounted

Typical overhead mounted sign arrangements are shown for four way intersections and for “T” intersections in this chapter. These figures do not cover every situation, but only the more commonly occurring situations.

- a. **Left Turn Signal Signs (R10-5, R10-12, R10-21, R10-16, R10-17a, W25-1 and W25-2)**
 - i. **“Left On Green Arrow Only” Sign (R10-5)³⁸**
 - Optional
 - Used for “protected only” left turns
 - Place to the left of the signal head it is intended for
 - ii. **“Left Turn Yield on Green Ball” Sign (R10-12)³⁹**
 - Optional
 - Used for “permissive only” left turns if a flashing yellow arrow is not installed
 - Used for “protected/permissive” left turns where the signal face is shared with another movement
 - Place to the left of the signal head it is intended for.

³⁸ MUTCD, 2009, Part 2, p. 95, Section 2B.53

³⁹ MUTCD, 2009, Part 2, p. 95, Section 2B.53

iii. “Left Turn Yield on Green Ball” (R10-12)⁴⁰

- Mandatory, unless a flashing yellow arrow is installed
- Used for “protected/permissive” left turns where a separate signal face is provided.
- Place to the left of the signal head it is intended for.

iv. “U Turn Yield to Right Turn” (R10-16)⁴¹

- Optional
- Used if U turns are permitted on a protected left turn movement on an approach from which drivers making a right turn from the conflicting approach are simultaneously being shown a right turn green arrow signal indication
- Place to the right of the signal head it is intended for

v. Left on Red After Stop” (R10-17a)

- Required sign for signalized U-turns that allow turn while the signal is red.
- Placed to the left of left most signal head.

vi. “Oncoming Traffic Has Extended Green” (W25-1) and “Oncoming Traffic May Have Extended Green” (W25-2)⁴²

- To be used when a “yellow trap” cannot be programmed out. See Chapter 3, Part B.3 Section f for more information on the “yellow trap”.
- Place to the right of the intended signal head.

b. Lane Control Signs (Signs R3-5 thru R3-6)⁴³

The following lane control signs are required and shall be installed over the lanes to the signal head’s right to which they apply as stated below. Additionally, advanced overhead signing shall be provided when a lane restricts you to a certain destination and precludes you from all others.:

i. Double Turn Lanes

- Where double turning movements are specified from two lanes.

⁴⁰ MUTCD, 2009, Part 2, p. 95, Section 2B.53

⁴¹ MUTCD, 2009, Part 2, p. 95, Section 2B.53

⁴² MUTCD, 2009, Part 2, p. 128, Section 2C.48

⁴³ MUTCD, 2009, Part 2, p. 61, Section 2B.19

ii. Shared Lanes

- For two or more movements from a specific lane where a movement, not normally allowed, is permitted.

iii. T – Intersections

- If the dead-end approach is a multi-lane approach, all lane movement shall be designated.

c. Turn Prohibition Signs (Signs R3-1, R3-2, R3-4, R10-17a)

i. No Right Turn (symbol) Sign (R3-1)⁴⁴

- Mandatory
- Used where a right turn is prohibited
- Placed to the right of the right most signal head on the approach

ii. No Left Turn (symbol) Sign (R3-2)⁴⁵

- Mandatory
- Used where a left turn is prohibited
- Place to the left of the left most signal head on the approach

iii. No U-Turn (symbol) Sign (R3-4)⁴⁶

- Mandatory
- Used where U-turns are prohibited
- Place to the left of the left most signal head if no median exists (if a median exists, sign should be ground mounted)
- Typical applications are as follows:
 - Crashes – Where there are more than five crashes in a twelve-month period involving U-turning vehicles and side street right turning traffic and the R10-16 sign (if applicable) has been installed for that 12-month period.
 - Limited Area – Where there is insufficient room to make a U-turn.

iv. “No Turn on Red” (R10-11a)

- Required when a left on red at a signalized U-turn is not allowed.
- Placed to the left of left most signal head.

⁴⁴ MUTCD, 2009, Part 2, p. 60, Section 2B.18

⁴⁵ MUTCD, 2009, Part 2, p. 60, Section 2B.18

⁴⁶ MUTCD, 2009, Part 2, p. 60, Section 2B.18

d. Right Turn Signs (R10-11a and R10-15)

i. “No Turn on Red” (R10-11a)⁴⁷

- Mandatory
- Used where a right turn on red is prohibited
- Place to the right of the right most signal head
- Typical application are as follows:
 - Sight Distance – Where sight distance to the left is insufficient.
 - Service Roads – Where there is an adjacent parallel service road to the right.
 - Pedestrian Phase – Where there is an exclusive pedestrian signal phase.
 - Crashes – Where there are 3 or more right turn on red crashes in a 12-month period.
 - Dual Left Turn – When facing an opposing dual left turn.

ii. “Turning Traffic MUST Yield To Pedestrians” (R10-15)⁴⁸

- Optional
- Used for signals with a protected pedestrian phase to remind drivers who are making a right turn on red to yield to pedestrians.
- Placed to the right of the right most signal head.

e. Street Name Signs (D3-1)⁴⁹

- See LADOTD Traffic Engineer Manual Section 2D.8 – Installation and Maintenance of Local Street Name Signs.
- Installed by others only where an agreement with a local government exists to install and maintain the signs - DOTD does not install or maintain these signs.
- Place on diagonally opposite corners and on the far right side with respect to motorists on the major street.
- The signs shall have white letters on a green background and shall be retro reflective.
- Types of mountings:
 - Strain poles/mast arm poles – Street name signs can be bracket mounted to strain poles or mast arm poles. The letter size for these signs are 6” for upper case and 4 1/2” for lower case letters.

⁴⁷ MUTCD, 2009, Part 2, p. 95, Section 2B.54

⁴⁸ MUTCD, 2009, Part 2, p. 95, Section 2B.53

⁴⁹ MUTCD, 2009, Part 2, p. 161, Section 2D.43

f. Blank Out Signs

These are internally illuminated signs that are blanked out (show no message) when not illuminated. They are typically used when a turn prohibition is in effect only at certain times of the day. Typical applications can include:

- Railroad preemption – where left and right turns towards the tracks are prohibited during preemption.
- Peak hour – where left or right turns are prohibited during peak hours due to congestion.

g. Ground Mounted Signs

Ground mounted signs to be used at or in advance of signalized intersections are as follows:

i. “T” Intersection

For Dead End Installation see HS-03 (Standard Plan for Object Markers, Milepost and Dead End Road Installations)

ii. “Left (Right) Lane Must Turn Left (Right)” (R3-7(R))⁵⁰

- Optional
- Used where:
 - separate turn lanes greater than 200 feet in length exists, and
 - where turning movement traffic frequently fills these lanes to capacity, and
 - where lane use arrow markings exists
- Installed at the beginning of the turn lane

iii. Signal Ahead Sign (W3-3)⁵¹

See LADOTD Traffic Engineering Manual

h. Sign Size

Traffic signs used at LADOTD signalized intersections shall be of the size specified in the MUTCD. The unit measurement for these signs as shown in signal plans shall be in square feet of the sign face.

⁵⁰ MUTCD, 2009, Part 2, p. 61, Section 2B.19

⁵¹ MUTCD, 2009, Part 2, p. 123, Section 2C-36

i. Sign Placement

- Overhead signs shall have a minimum of 17.5 feet vertical clearance over the roadway. On routes designated by LADOTD as large load routes sign height should be increased.
- For warning sign placement see MUTCD 2009 Table 2C-4 (page 108).
- Figure 4-29 through Figure 4-43 show sign placement.

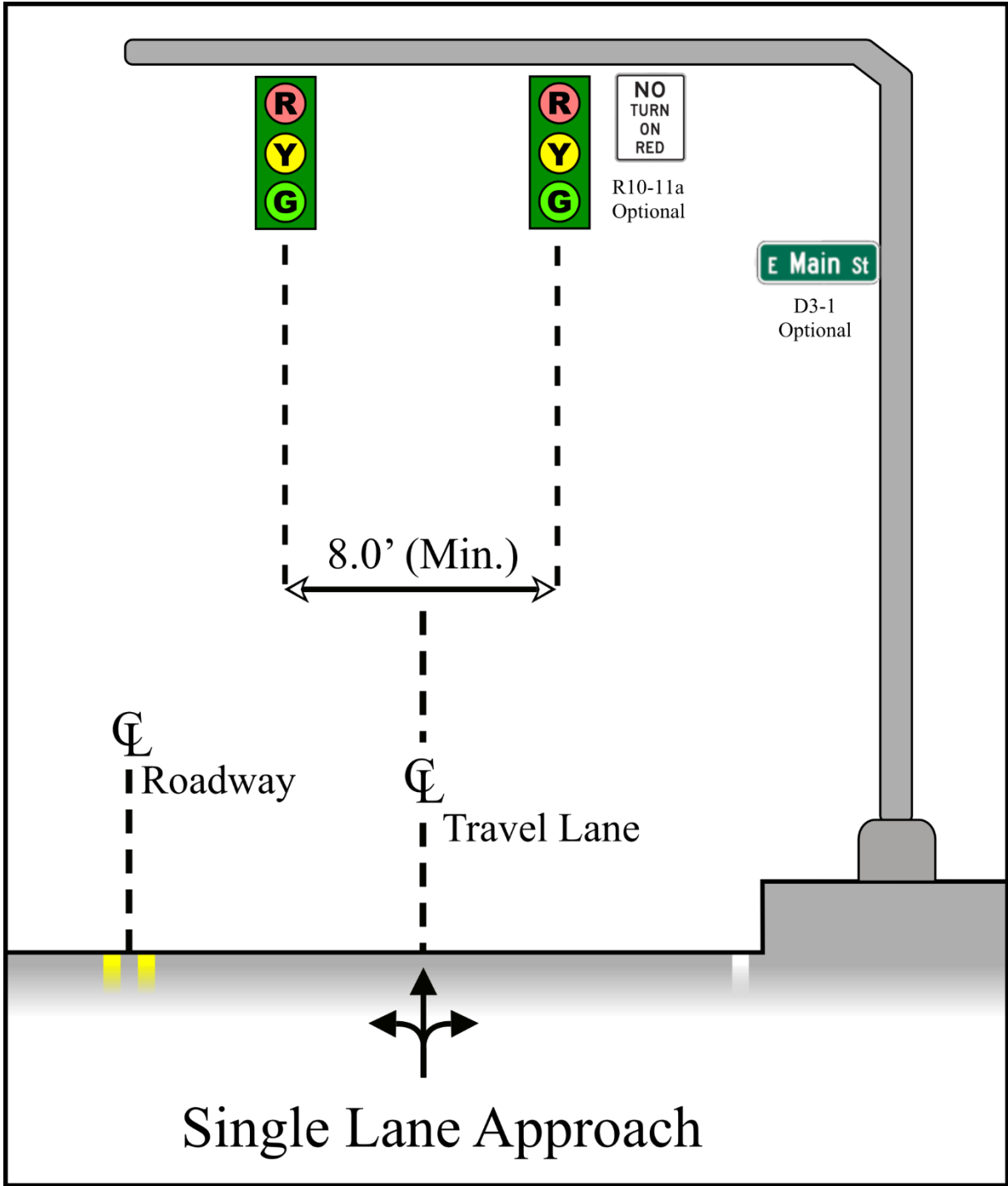

Figure 4-29 Sign Placement: Single Lane Approach Example 1

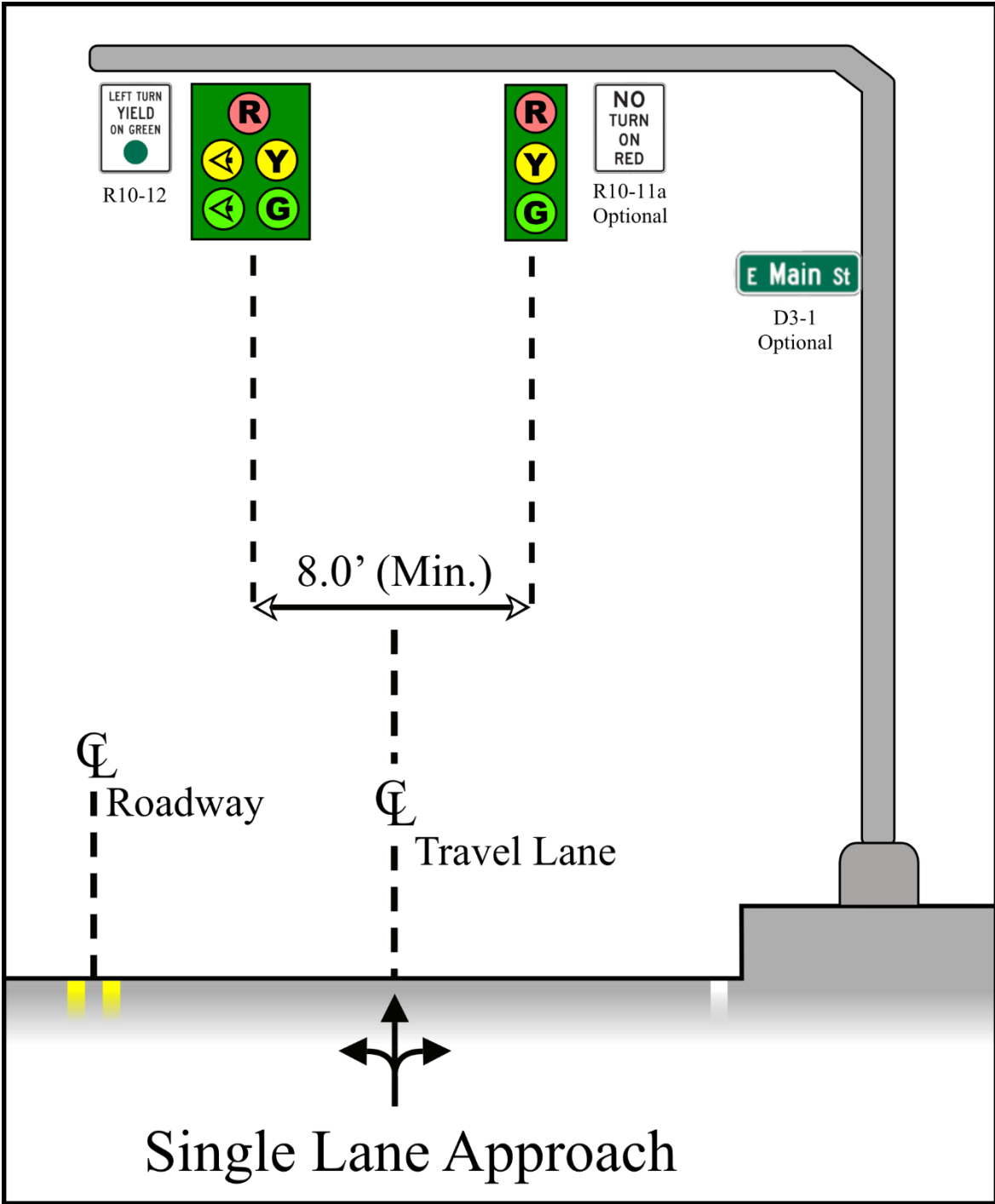

Figure 4-30 Sign Placement: Single Lane Approach Example 2

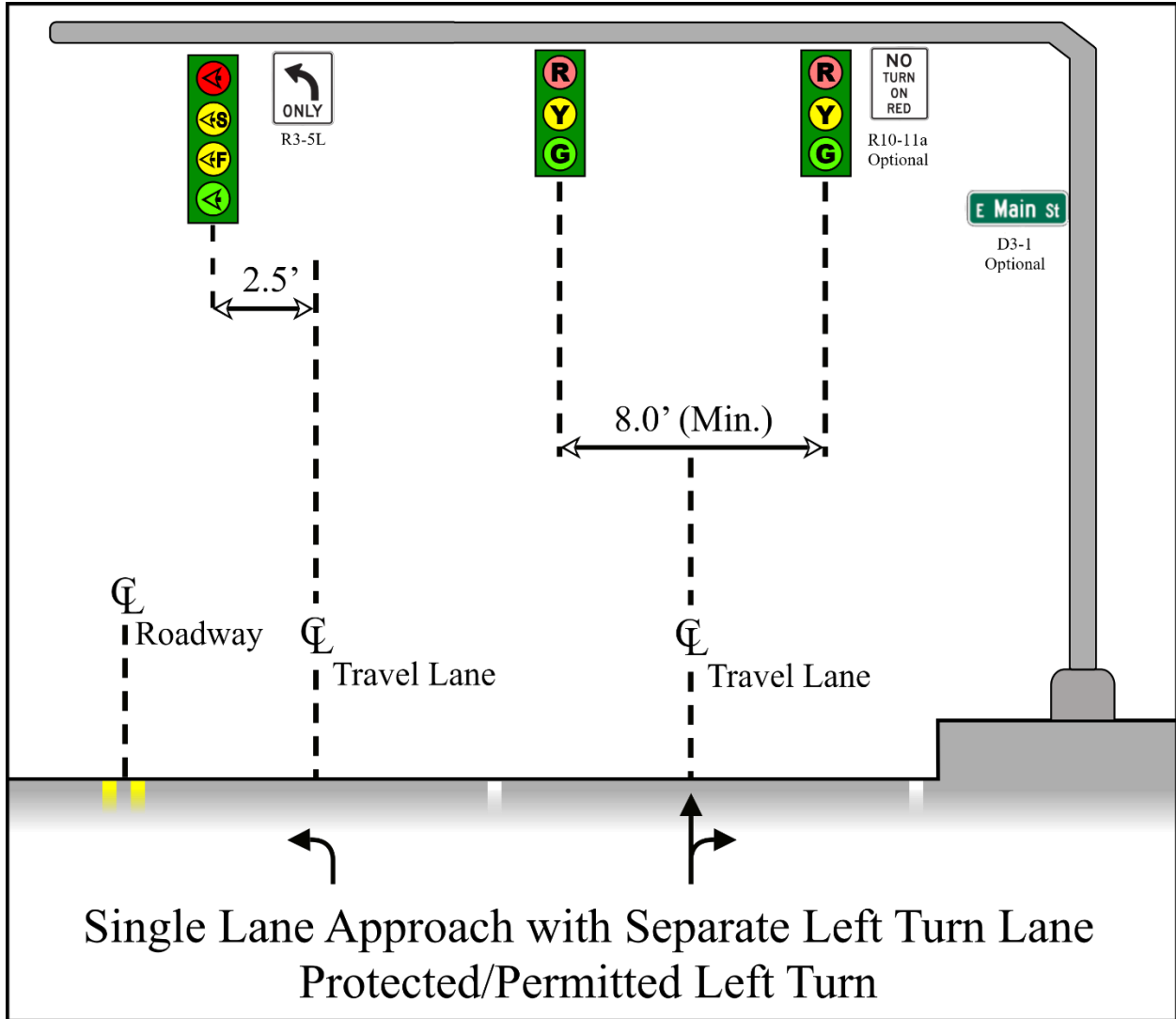

Figure 4-31 Sign Placement: Single Lane Approach with Separate Left Turn Lane
 Protected/Permitted Left

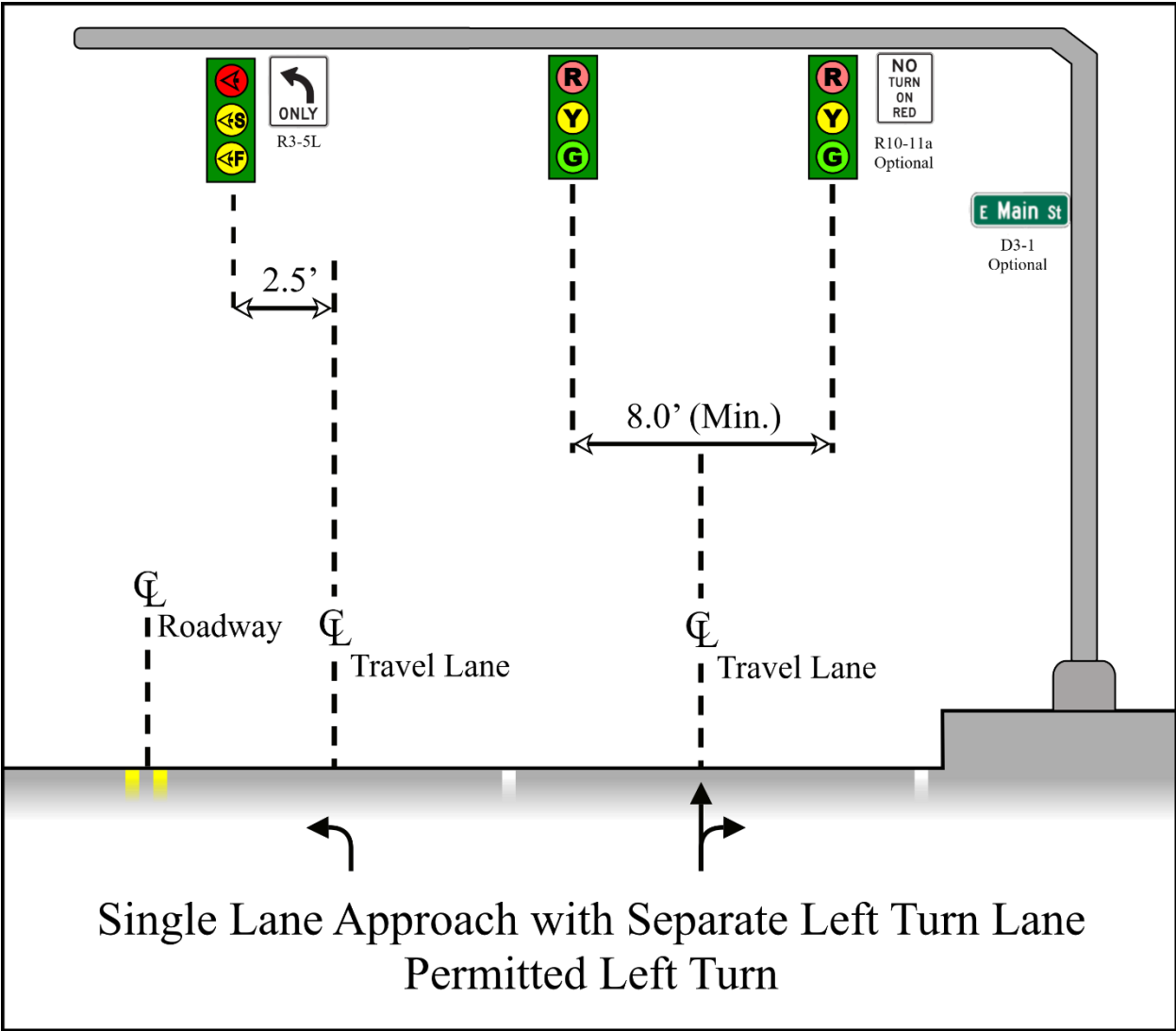

Figure 4-32 Sign Placement: Single Lane Approach with Separate Left Turn Lane Permitted Left Turn Lane

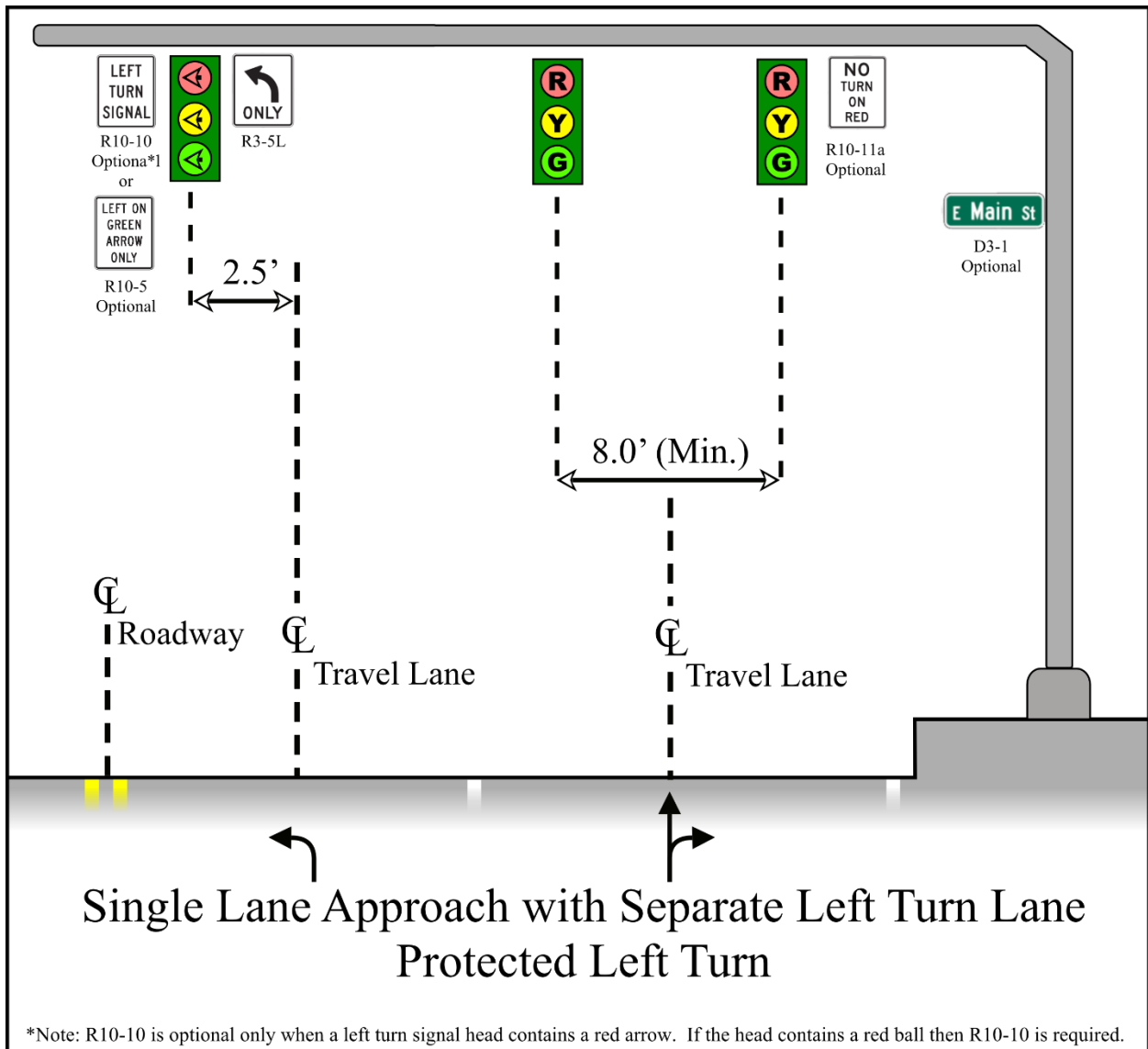

Figure 4-33 Sign Placement: Single Lane Approach with Separate Left Turn Lane Protected Left Turn

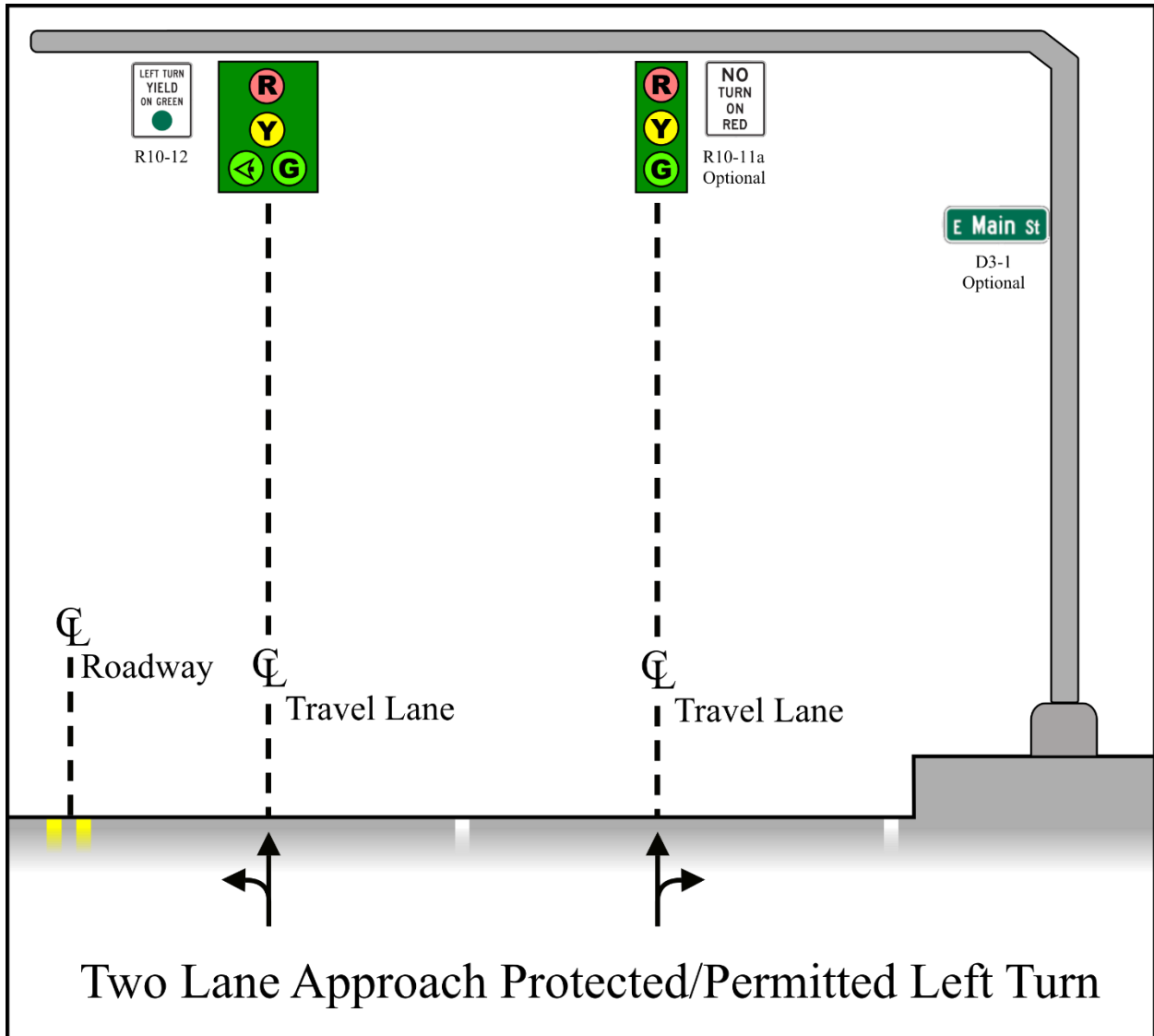

Figure 4-34 Sign Placement: Two Lane Approach Protected/Permitted Left Turn

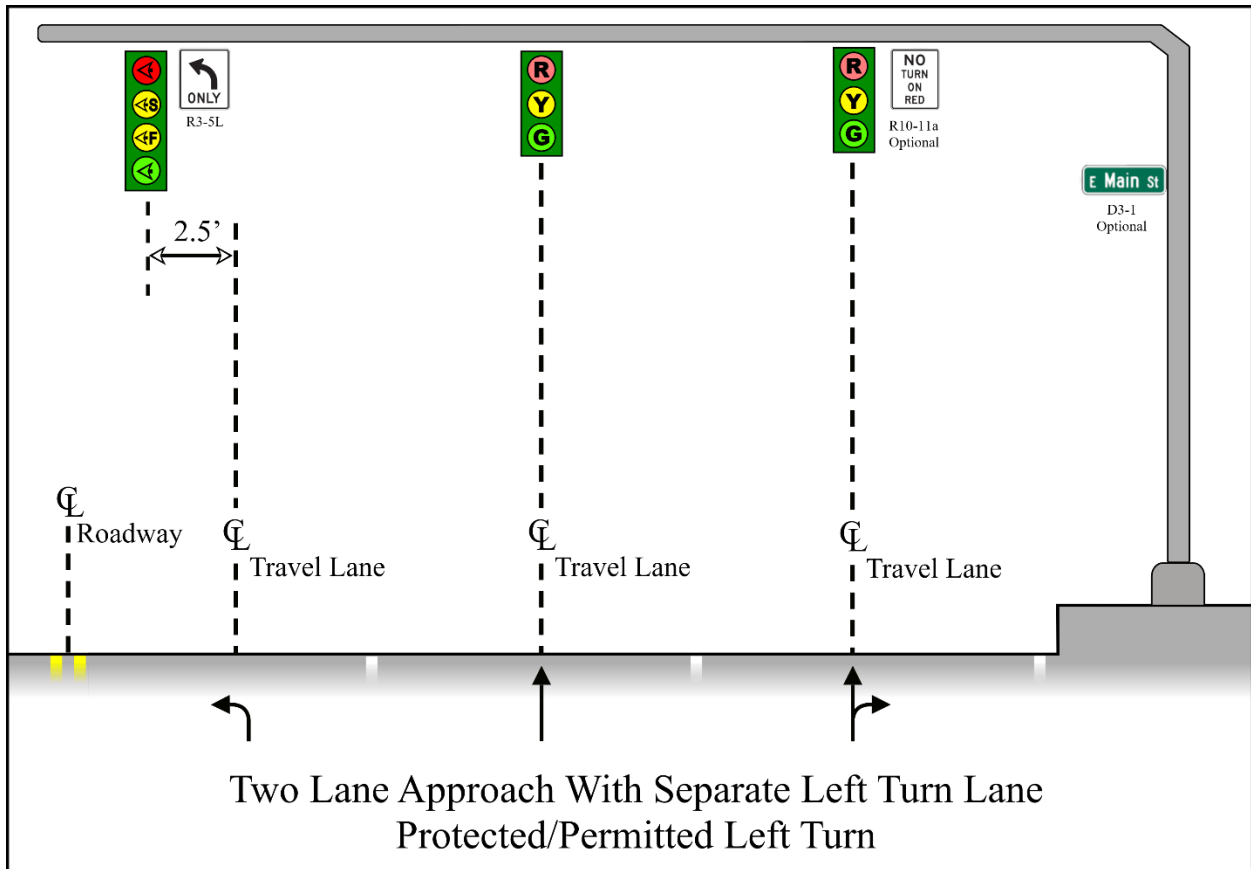

Figure 4-35 Sign Placement: Two Lane Approach with Separate Left Turn Lane Protected/Permitted Left Turn

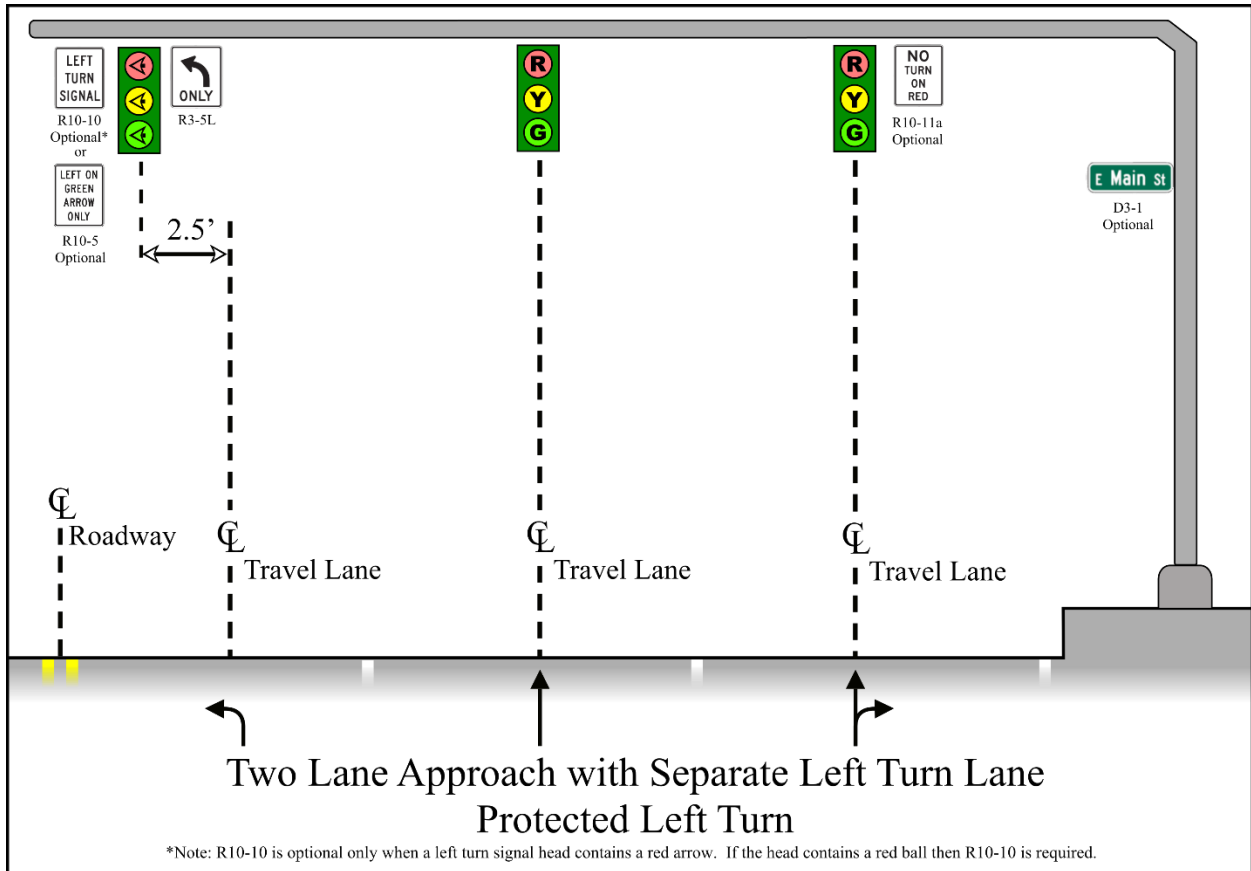

Figure 4-36 Sign Placement: Two Lane Approach with Separate Left Turn Lane Protected Left Turn

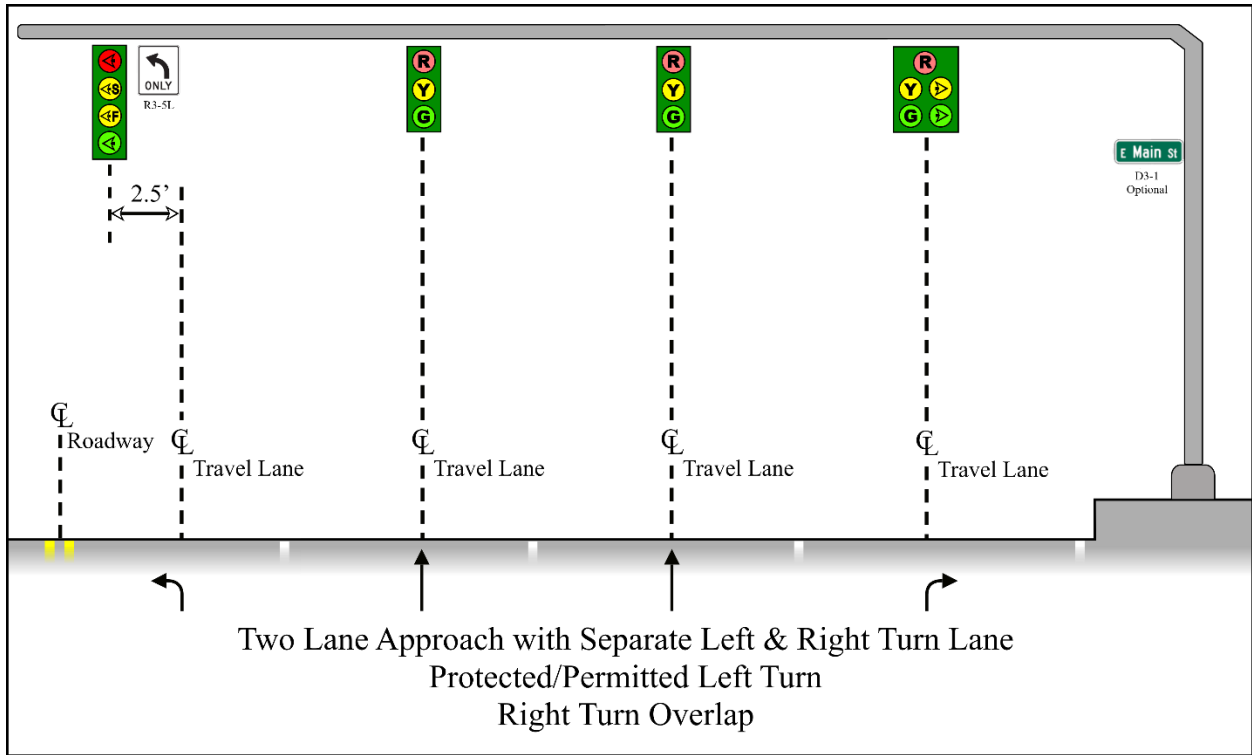

Figure 4-37 Sign Placement: Two Lane Approach with Separate Left & Right Turn Lane Protected/ Permitted Left Turn with Right Turn Overlap

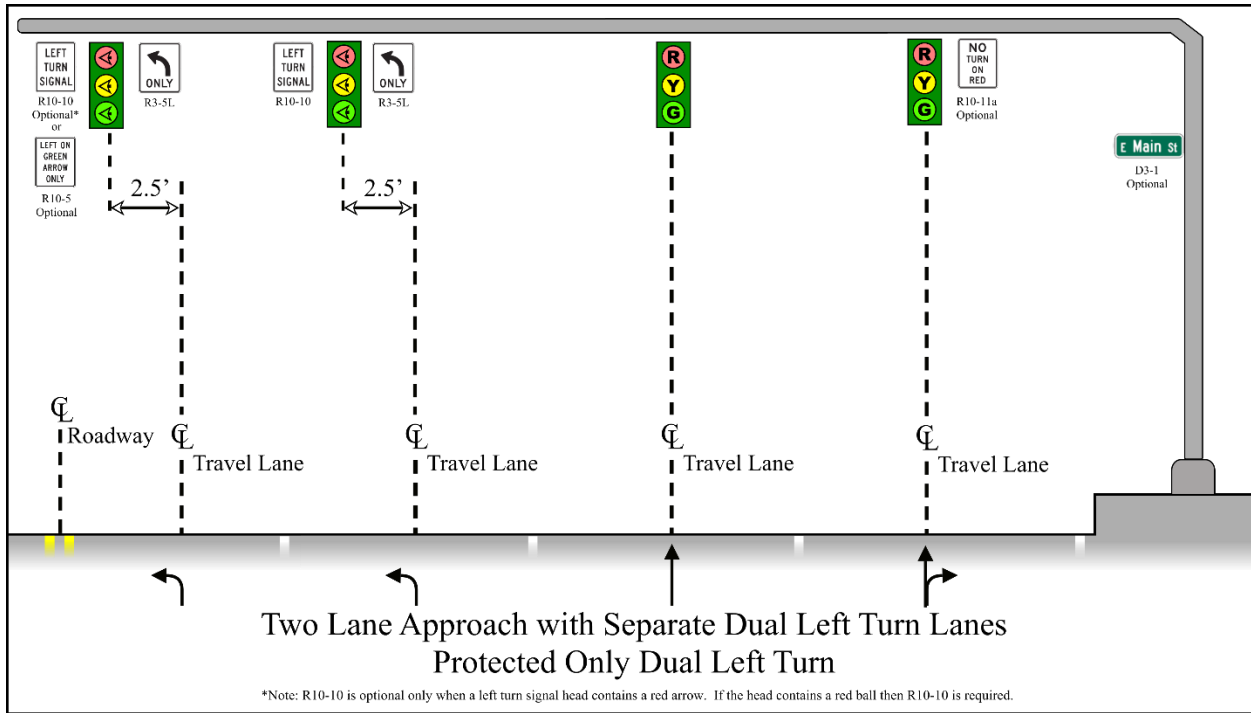

Figure 4-38 Sign Placement: Two Lane Approach with Separate Dual Left Turn Lanes Protected Only Dual Left Turn

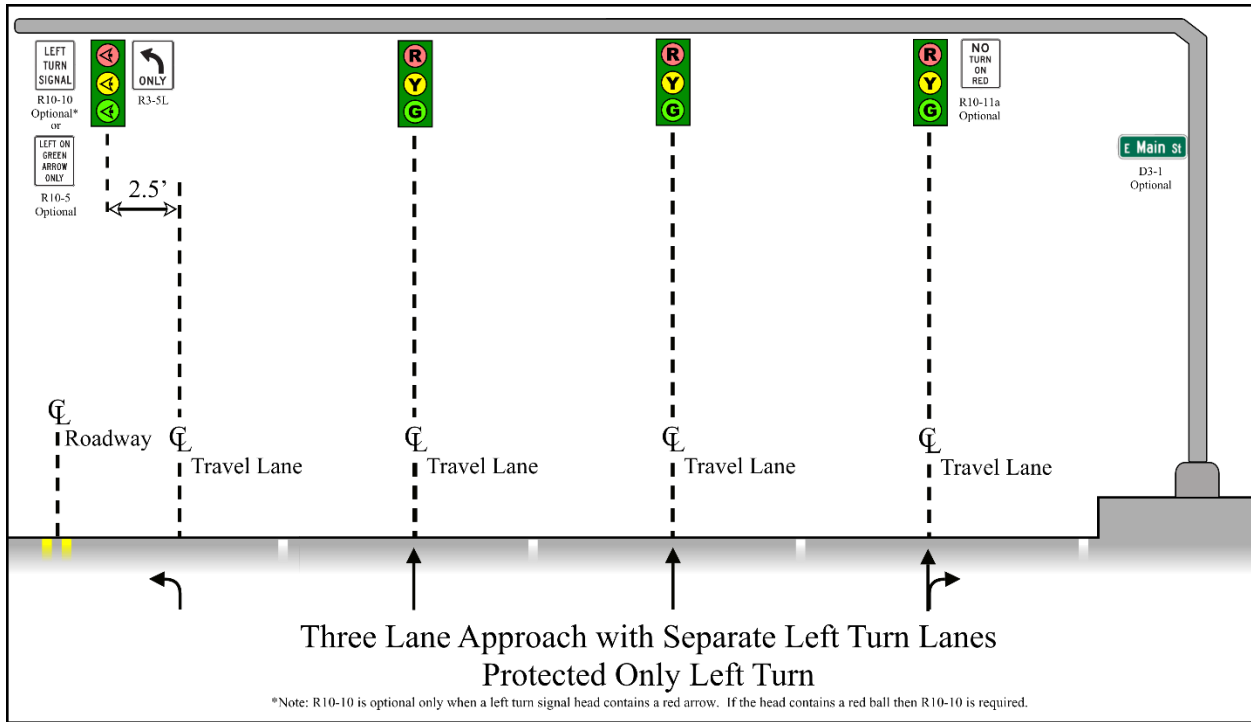

Figure 4-39 Sign Placement: Three Lane Approach with Separate Left Turn Lane Protected Only Left Turn

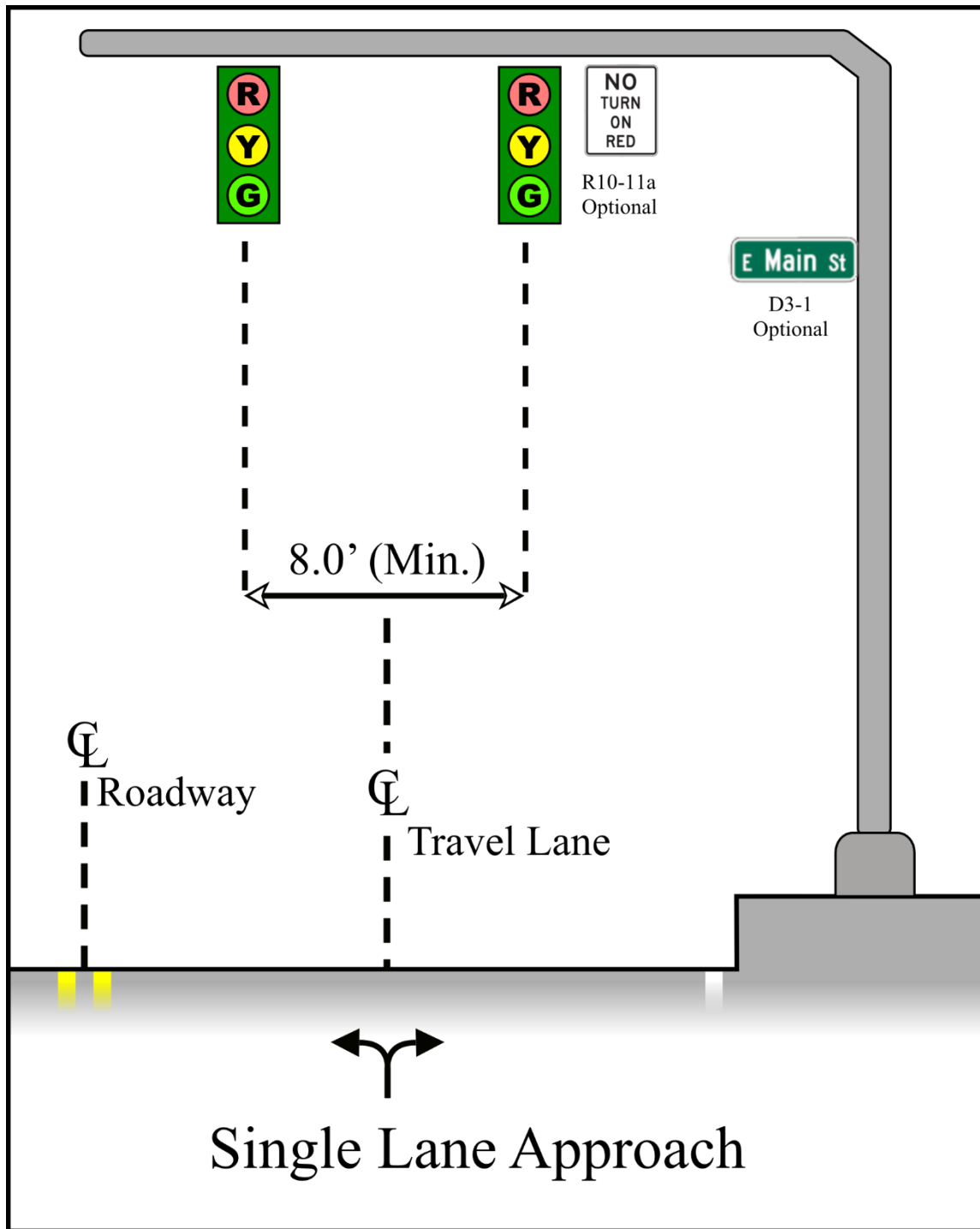

Figure 4-40 Sign Placement: Single Lane Approach No Through Movement

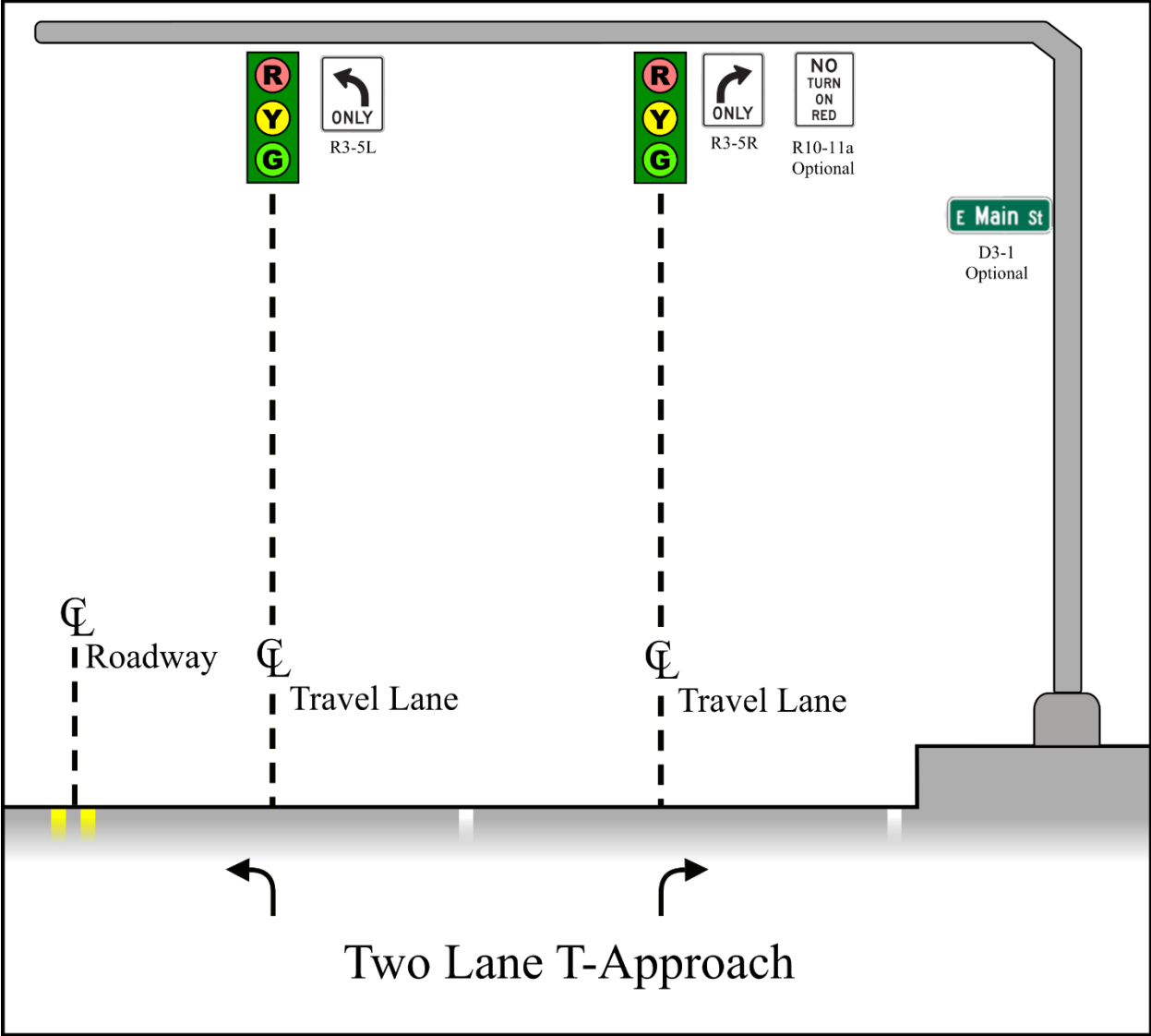

Figure 4-41 Sign Placement: Two Lane Approach Protected/Permitted Left Turn

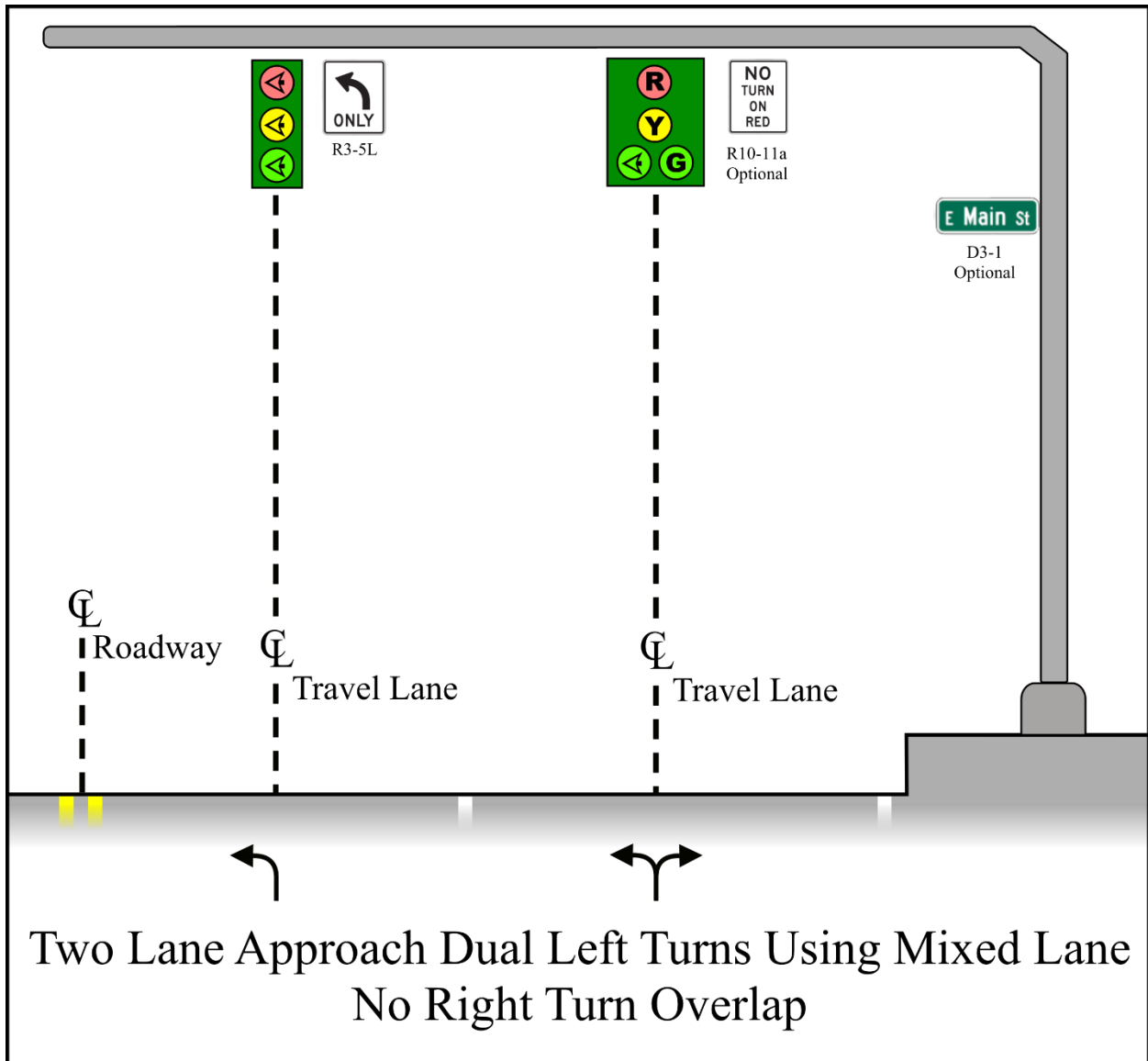

Figure 4-42 Sign Placement: Two Lane Approach Dual Left Turns Using Mixed Lanes No Right Turn Overlap

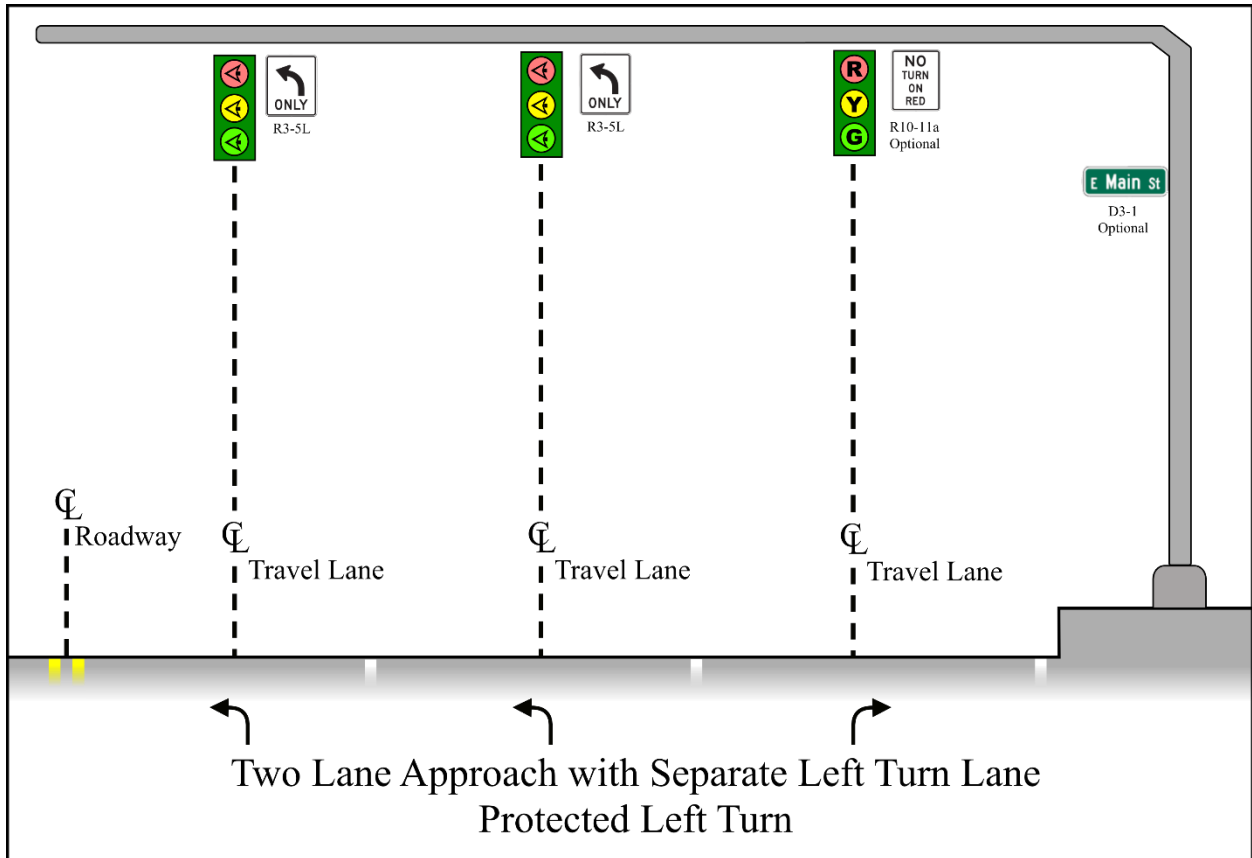

Figure 4-43 Sign Placement: Two Lane Approach with Separate Left Turn Lane Protected Left Turn

j. Internally Illuminated Signs

Internally illuminated signs can be used at LADOTD signalized intersections if a full signal maintenance agreement exists with the local government to install and maintain. Where used they shall include only traffic control signs or street name signs that are mast arm mounted.

k. LADOTD SIGN TYPES

LADOTD signs are classified by type as follows:

- Type A - Small size, single post mounted.
- Type B - Cluster assembly of type A signs.
- Type C - Fold down signs.
- Type D - Large rectangular signs that are ground mounted with multiple posts.
- Type E - Large overhead signs that are cantilever, truss fascia mounted.

5 TRAFFIC SIGNAL INVENTORY & SIGNAL PLANS

The following chapter explains LADOTD's Traffic Signal Inventory (TSI). To help explain the TSI an example has been provided in this chapter and in the appendix. The example is of a fictitious intersection and has been designed to help show the different facets of the TSI forms.

5.1 Traffic Signal Inventory

A Traffic Signal Inventory (TSI) is a set of 8½" x 11" pages that summarize the critical information concerning installation, operation, and timing of a traffic signal. Copies of these forms are kept in the signal controller cabinet, at the LADOTD's District Traffic Operations Office, and at LADOTD's Traffic Services.

5.1.1 When Required

A Traffic Signal Inventory (TSI) is to be prepared and submitted when any of the following occurs:

- **Permit Work** - A new TSI is required any time work around a signalized intersection modifies the signal, its operation or the intersection geometry.
- **New Signal Design** - A TSI is required any time a new signal installation is designed a TSI is required. When the new signal installation involves construction or signal plans, the TSI shall accompany the set of final plans.
- **Signal Modifications** - An updated TSI is required any time an existing signal has a hardware or timing modification. When the signal modification involves construction or signal plans, the TSI shall accompany the set of final plans. When the modification involves timing changes the TSI should be created once the final timing modifications have been performed.

5.1.2 **Provided Formats**

When a Traffic Signal Inventory (TSI) is updated the following formats must be provided:

- Printed copies of all TSI pages
- Microstation files with embedded excel TSI files and a drawn signal layout; a signal layout image shall not be pasted in the file
- PDF file of all TSI pages

5.1.3 **Traffic Signal Inventory**

A complete Traffic Signal Inventory (TSI) usually consists of the following, arranged in the order shown:

- a. Sequence & Coordination Plan Page
- b. Supplemental Sequence & Coordination Plan Page (when applicable)
- c. Phase Timing Parameters Page
- d. Intersection Diagram Page
- e. Intersection Wiring Diagram Page (only for construction)
- f. Intersection Count and Detection Page
- g. Preemption Page (when applicable)
- h. Modification and Inspection Record Page

5.1.4 **Traffic Signal Inventory Page Requirements**

The following lists the minimum requirements for each TSI page.

a. Sequence & Coordination Plan Page

This page states the sequencing for both free operation and each coordination plan. The page requires each of the following:

- Traffic Signal Inventory Number
- Intersection Name
- City
- Parish
- Signal Type
- Interconnect Type
- Control Section and Logmile
- Latitude and Longitude

- Controller IP Address (Required for Signals that have an IP address.)
- Signal Installation Date –The initial signal installation date.
- Signal Revision Date – The most recent TSI update.
- Signal Timing Coordination Schedule
- Free Operation Action (Only when additional space is needed to show Free Operation(s) action)
 - Sequence Diagram
 - Phasing
 - Ring 1 & 2 Signal Head Interval Designations
 - Pattern Number
 - Sequence Number
 - Maximum setting (Min, Max or Max Inhibit)
 - Ring Phases
- Each Coordinated Action requires the following
 - Phasing
 - Pattern/Split Number – These numbers shall be the same for each action
 - Split Times
 - Interval Times
 - Offset
 - Sequence Diagram
 - Ring 1 & 2 Signal Head Interval Designations
 - Ring Phases
 - Action Number
 - Cycle Length
 - Sequence Number
 - Coordination Phase
 - Maximum setting (Min, Max or Max Inhibit)

TRAFFIC SIGNAL INVENTORY (v3.2)														TSI NO. 88-343		
LOUISIANA DEPARTMENT OF TRANSPORTATION AND DEVELOPMENT														PAGE: 1 OF 8		
INTERSECTION: LA 117 @ Cortana Rd.				CTRL SEC: 343-01				LOGMILE: 1.17								
CITY: Example-Ville				PARISH: Exaplana				LAT: 30.38792				LONG: -91.069035				
SIGNAL TYPE: Volume Density				INTERCONNECT TYPE: GPS & Fiber				REV. DATE: 7/1/2020				INSTALL DATE: 11/15/2001				
MAINTAINED BY: DOTD				COORDINATED WITH TSI #S:				88-113, 88-117 & 88-340								
TRAFFIC SIGNAL COORDINATION PLANS (PHASING MAY VARY FROM FREE OPERATION)																
Ring 1	Φ1	Turn	<FY	<SY	<R							<G	<G	<SY		1
	Φ2	Thru	G	G	G	G	Y	R				R	R	R		4,5
	Φ4	Turn							--	--	--					8
	Φ4	Thru							G	Y	R					7,8
Ring 2	Φ5	Turn	<FY	<FY	<FY	<G	<Y	<R				G	G	G		6
	Φ6	Thru	G	Y	R	R	R	R								2,3
	Φ8	Turn							--	--	--					9
	Φ8	Thru							G	Y	R					9,10
PEDs 2	Φ6	PED(6)	DW	DW	DW	DW	DW	DW	DW	DW	DW	DW	DW	DW		11,12
OVERLAP																
Int. Times			36	4	1	10	4	1	15	4	1	5	5	4		Signal Heads
Phasing			Φ2 + Φ6			Φ2 + Φ5			Φ4 + Φ8			Φ1 + Φ6				
Split			sec 56			55			56			15				
Coord Φ: Φ2			↓ ↓ ↓			↓ ↓ ↓			↑ ↑ ↑			↑ ↑ ↑			Offset =	
Max:			↓ ↓ ↓			↓ ↓ ↓			↑ ↑ ↑			↑ ↑ ↑			7 sec	
PEDs/Action:			↑ ↑ ↑			↑ ↑ ↑			↑ ↑ ↑			↑ ↑ ↑			Cycle Length:	
Times of Operation:			Mon. - Fri.:			15:00 - 18:00			Sat.:			Sun.:			90	
Notes: 3 sec delay for Flashing Yellow Arrow																
Ring 1	Φ1	Turn	--	--	--							<G	<Y	--		1
	Φ2	Thru	G	Y	R							R	R	R		1,4,5
	Φ4	Turn				<G	--	--								8
	Φ4	Thru				G	Y	R								7,8
Ring 2	Φ5	Turn	--	--	--							<G	<Y	--		6
	Φ6	Thru	G	Y	R							R	R	R		2,3,6
	Φ8	Turn							<G	--	--					9
	Φ8	Thru							G	Y	R					9,10
PEDs 2	Φ6	PED(6)	DW	DW	DW	DW	DW	DW	DW	DW	DW	DW	DW	DW		11,12
OVERLAP																
Int. Times			30	4	1	15	4	1	10	4	1	5	4	1		Signal Heads
Phasing			Φ2 + Φ6			Φ4			Φ8			Φ1 + Φ5				
Split			sec 35			35			20			15				
Coord Φ: Φ6			↓ ↓ ↓			↓ ↓ ↓			↑ ↑ ↑			↑ ↑ ↑			Offset =	
Max:			↓ ↓ ↓			↓ ↓ ↓			↑ ↑ ↑			↑ ↑ ↑			14 sec	
PEDs/Action:			↑ ↑ ↑			↑ ↑ ↑			↑ ↑ ↑			↑ ↑ ↑			Cycle Length:	
Times of Operation:			Mon. - Fri.:			06:00 - 09:00			Sat.:			Sun.:			80	
Notes: 3 sec delay for Flashing Yellow Arrow																

Figure 5-1 Sequence & Coordination Plan Page

b. Supplemental Sequence & Coordination Plan Page

The Supplemental Sequence & Coordination Plan Page has the same requirements as the Sequence & Coordination Plan Page. This page should be used when not all information can be shown on the initial Sequence & Coordination Plan Page.

TRAFFIC SIGNAL INVENTORY (v3.2)												TSI NO. 88-343		
LOUISIANA DEPARTMENT OF TRANSPORTATION AND DEVELOPMENT												PAGE: 2 OF 8		
INTERSECTION: LA 117 @ Cortana Rd.				CTRL SEC: 343-01				LOGMILE: 1.17						
CITY: Example-Ville				PARISH: Exaplana				LAT: 30.38792				LONG: -91.069035		
TRAFFIC SIGNAL COORDINATION PLANS (PHASING MAY VARY FROM FREE OPERATION)														
Ring 1	Φ1	Turn	--	--	--				<G	<Y	--			1
	Φ2	Thru	G	Y	R				R	R	R			1,4,5
	Φ4	Turn				--	--	--						8
	Φ4	Thru				G	Y	R						7,8
Ring 2	Φ5	Turn	--	--	--				<G	<Y	--			6
	Φ6	Thru	G	Y	R				R	R	R			2,3,6
	Φ8	Turn				--	--	--						9
	Φ8	Thru				G	Y	R						9,10
PEDs 2	Φ6	PED(6)	DW	DW	DW	DW	DW	DW	DW	DW	DW			
	OVERLAP													
Hurricane Evacuation														
Int. Times		117	4	1	10	4	1	5	4	1				Signal Heads
Phasing		Φ2 + Φ6			Φ4 + Φ8			Φ1 + Φ5						
Split	sec	85	85	15	15	10	10							
Coord Φ:		Φ6			Φ8			Φ1			Φ5			Offset = 5 sec
Max:		↓ ↓ ↓			↑ ↑ ↑			← ← ←			→ → →			Cycle Length: 147
MAX INHIBIT														
Pattern/Split:		9												
Action:		9												
Times of Operation:		Mon. - Fri.:						Sat.:			Sun.:			
Notes: 3 sec delay for Flashing Yellow Arrow														
Ring 1														
	PEDs 1													
	Ring 2													
	PEDs 2													
OVERLAP														
Int. Times														Signal Heads
Phasing														
Split	sec													
Coord Φ:														Offset = sec
Max:														
Pattern/Split:		1												Cycle Length: 0
Action:		1												
Times of Operation:		Mon. - Fri.:						Sat.:			Sun.:			
Notes:														

Figure 5-2 Supplemental Sequence & Coordination Plan Page

c. Supplemental Pedestrian Sequence & Coordination Plan Page

The Supplemental Pedestrian Sequence & Coordination Plan Page has the same requirements as the Sequence & Coordination Plan Page. The only addition to this page is pedestrian intervals for each plan.

TRAFFIC SIGNAL INVENTORY (v3.2)															TSI NO. 88-343				
LOUISIANA DEPARTMENT OF TRANSPORTATION AND DEVELOPMENT															PAGE: 3 OF 8				
INTERSECTION: LA 117 @ Cortana Rd.					CTRL SEC: 343.01					LOGMILE: 1.17									
CITY: Example-Ville					PARISH: Exampiana					LAT: 30.38792					LONG: .91069035				
SIGNAL TYPE: Volume Density					INTERCONNECT TYPE: GPS & Fiber					REV. DATE:					INSTALL DATE:				
SIGNAL WARRANTS:					MAINTAINED BY:					CONT. MANUF: Trafficware					SYS#: 88-113, 88-117 & 88-340				
MAINTAINED BY: DOTD					COORDINATED WITH TSI #'S:					Controller IP: 117.0.343.0									
TRAFFIC SIGNAL COORDINATION PLANS (PHASING MAY VARY FROM FREE OPERATION)																			
Ring 1	Φ1	Turn	--	--	--	--	--	--	--	--	--	--	--	--	--	--	1		
	Φ2	Thru	G	G	G	G	G	G	Y	R							4,5,6		
	Φ4	Turn															8		
	Φ4	Thru															7,8		
Ring 2	Φ5	Turn	--	--	--	--	--	--	--	--	--	--	--	--	--	--	6		
	Φ6	Thru	G	G	Y	R											1,2,3		
	Φ8	Turn															9		
	Φ8	Thru															9,10		
PEDs 2	Φ6	PED(s)	WA	FDW	DW	DW	DW	DW	DW	DW	DW	DW	DW	DW	DW	DW	11,12		
	OVERLAP																		
Int. Times															Signal Heads				
Phasing																			
Split sec																			
Coord Φ															Offset = 7 sec				
Max: MAX INHIBIT															Cycle Length: 90				
Pattern/Split: 1																			
Action: 1																			
Times of Operation: Mon - Fri: 15:00 - 18:00 Sat: Sun:																			
Notes: 3 sec delay for Flashing Yellow Arrow																			
Ring 1	Φ1	Turn	<FY	<FY	<SY	<R											1		
	Φ2	Thru	G	G	Y	R											4,5,6		
	Φ4	Turn															8		
	Φ4	Thru															7,8		
Ring 2	Φ5	Turn	<FY	<FY	<SY	<R											6		
	Φ6	Thru	G	G	Y	R											1,2,3		
	Φ8	Turn															9		
	Φ8	Thru															9,10		
PEDs 2	Φ6	PED(s)	WA	FDW	DW	DW	DW	DW	DW	DW	DW	DW	DW	DW	DW	DW	11,12		
	OVERLAP																		
Int. Times															Signal Heads				
Phasing																			
Split sec																			
Coord Φ															Offset = 14 sec				
Max: MAX INHIBIT															Cycle Length: 80				
Pattern/Split: 2																			
Action: 2																			
Times of Operation: Mon - Fri: 06:00 - 09:00 Sat: Sun:																			
Notes: 3 sec delay for Flashing Yellow Arrow																			

Figure 5-3 Supplemental Pedestrian Sequence & Coordination Plan Page

d. Phasing Timing Parameters Page

This page states the parameters for each traffic signal phase. All required fields are listed below:

- Traffic Signal Inventory Number
- Phase Mode
- Force off setting (Float or Fixed)
- Intersection name
- Min Green
- Gap, Extension (Used for Detection)
- Max Green I
- Max Green II
- Yellow Clearance
- Red Clearance
- Walk (Required for Pedestrian Timings)
- Ped Clearance (Required for Pedestrian Timings)
- Added Initial Green (Used for Volume Density)
- Maximum Initial (Used for Volume Density)
- Time Before Reduction (Used for Volume Density)
- Time To Reduce (Used for Volume Density)
- Reduce By (Used for Volume Density)
- Minimum Gap (Used for Volume Density)
- Recall
- Pedestrian Call (Used for Pedestrian)
- Lock Calls (Used for Detection)
- Signal head phase designations
- Free Operation Action
 - Sequence Diagram
 - Phasing
 - Ring 1 & 2 Signal Head Interval Designations
 - Pattern Number
 - Sequence Number
 - Maximum setting (Min, Max or Max Inhibit)
 - Ring Phases

TRAFFIC SIGNAL INVENTORY (v3.2)										TSI NO.	88-343	
LOUISIANA DEPARTMENT OF TRANSPORTATION AND DEVELOPMENT										PAGE:	4 OF 8	
Intersection: LA 117 @ Cortana Rd.												
Phasing Parameters												
Phase Mode	Force Off:	Phase #:	1	2	3	4	5	6	7	8		
STD8	Float	Movement:										
PARAMETER		RANGE(sec)										
MIN GREEN (MIN I)		0 - 99	5	15		10	5	15				
GAP, EXTENSION		0 - 10	3	3		3	3	3				
MAX GREEN I (MAX I)		0 - 255	10	30		15	10	30				
MAX GREEN II (MAX II)		0 - 255	20	60		25	20	60				
YELLOW CLEARANCE (YEL)		3 - 7	4	4		4	4	4				
RED CLEARANCE (RED)		1 - 4	1	1		1	1	1				
WALK (WALK)		0 - 100						7				
PED CLEARANCE (P CLR)		0 - 100						12				
ADDED INITIAL GREEN		0 - 10		3				3				
MAXIMUM INITIAL		0 - 255		15				15				
TIME BEFORE REDUCTION		0 - 255		10				10				
TIME TO REDUCE		0 - 255		15				15				
REDUCE BY		0 - 99										
MINIMUM GAP		0 - 10										
DYNAMIC MAX LIMIT		0 - 255										
DYNAMIC MAX STEP		0 - 25										
RECALL		MIN/MAX		MIN				MIN				
PEDESTRIAN CALL		ON/OFF										
LOCK CALLS		ON/OFF										
SOFT RECALLS		ON/OFF										
REST IN WALK		ON/OFF										
DUAL ENTRY		ON/OFF		ON				ON				
ADDITIONAL SIGNAL CONTROLLER SETTINGS												
Enable Simul Gap		ON/OFF		ON				ON				
TRAFFIC SIGNAL FREE OPERATION PHASING WHEN ALL PHASES ARE CALLED												
Ring 1	Φ1	Turn	<FY	<FY	<FY	<G	<SY	<R				1
	Φ2	Thru	G	Y	R							1,4,5
	Φ4	Thru							G	Y	R	7,8
Ring 2	Φ5	Turn	<FY	<FY	<FY	<G	<SY	<R				6
	Φ6	Thru	G	Y	R							2,3,6
	Φ8	Thru							G	Y	R	9,10
PEDs 2	Φ6	PED(6)	DW	DW	DW	DW	DW	DW	DW	DW	DW	11,12
OVERLAP												
Phasing		Φ2 + Φ6	Φ1 + Φ5	Φ4 + Φ8							Signal Heads	
Max:											Pattern/Split:	
Sequence #:											254	
Action:	10											
Times of Operation:		Mon. - Fri.:	00:00 - 06:00; 09:00 - 15:00; 18:00 - 00:00				Sat.:	ALL DAY	Sun.:	ALL DAY		
Notes:			3 sec delay for Flashing Yellow Arrow									

Figure 5-4 Phasing Timing Parameters Page

e. Intersection Diagram Page

The Intersection Diagram Page shows a visual representation of the intersection showing all hardware. The following information is required on all Intersection Diagram Pages:

- Basic Intersection Geometry
- North Arrow
- Signal Head Height
- Signal Heads
- Signal poles (Mast arms, strain poles, pedestals)
- Signal Detection Device and Detection Area (Cameras, Loops, etc.)
- Signs (MUTCD #, Size, and Label)
- Intersection Apparent Right-of-Way
- Route/Street Names
- Pavement Markings
- Driveways
- Ditches
- Utility poles
- Phase labels for approaches
- Lane designations (NB1, NB2, SB1, SB2.....)
- Detector labels and detection zone labels
- Mast arm lengths
- Backplate designation
- Traffic Signal Inventory number
- Existing speed limits
- Power supply location and pedestal if used

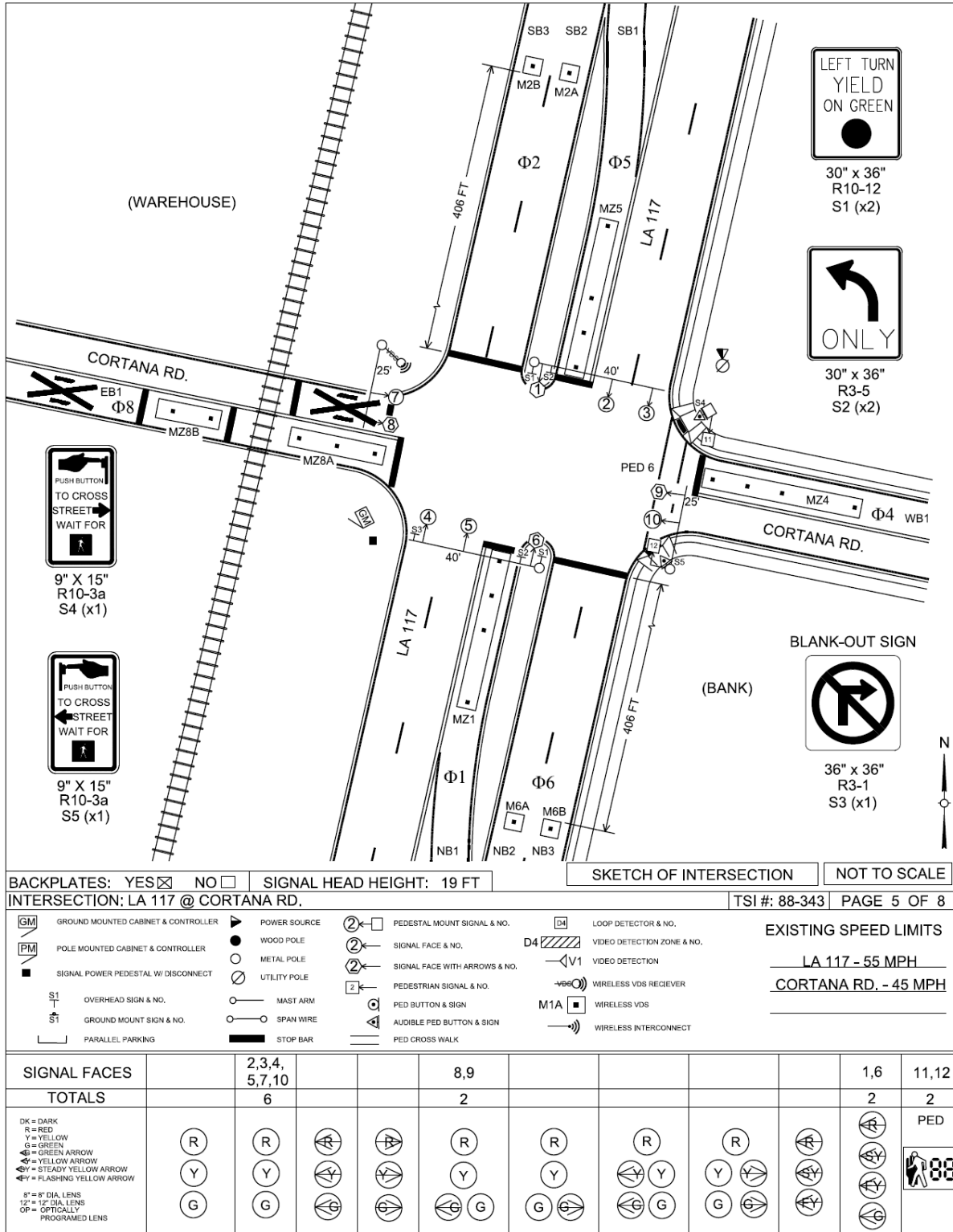
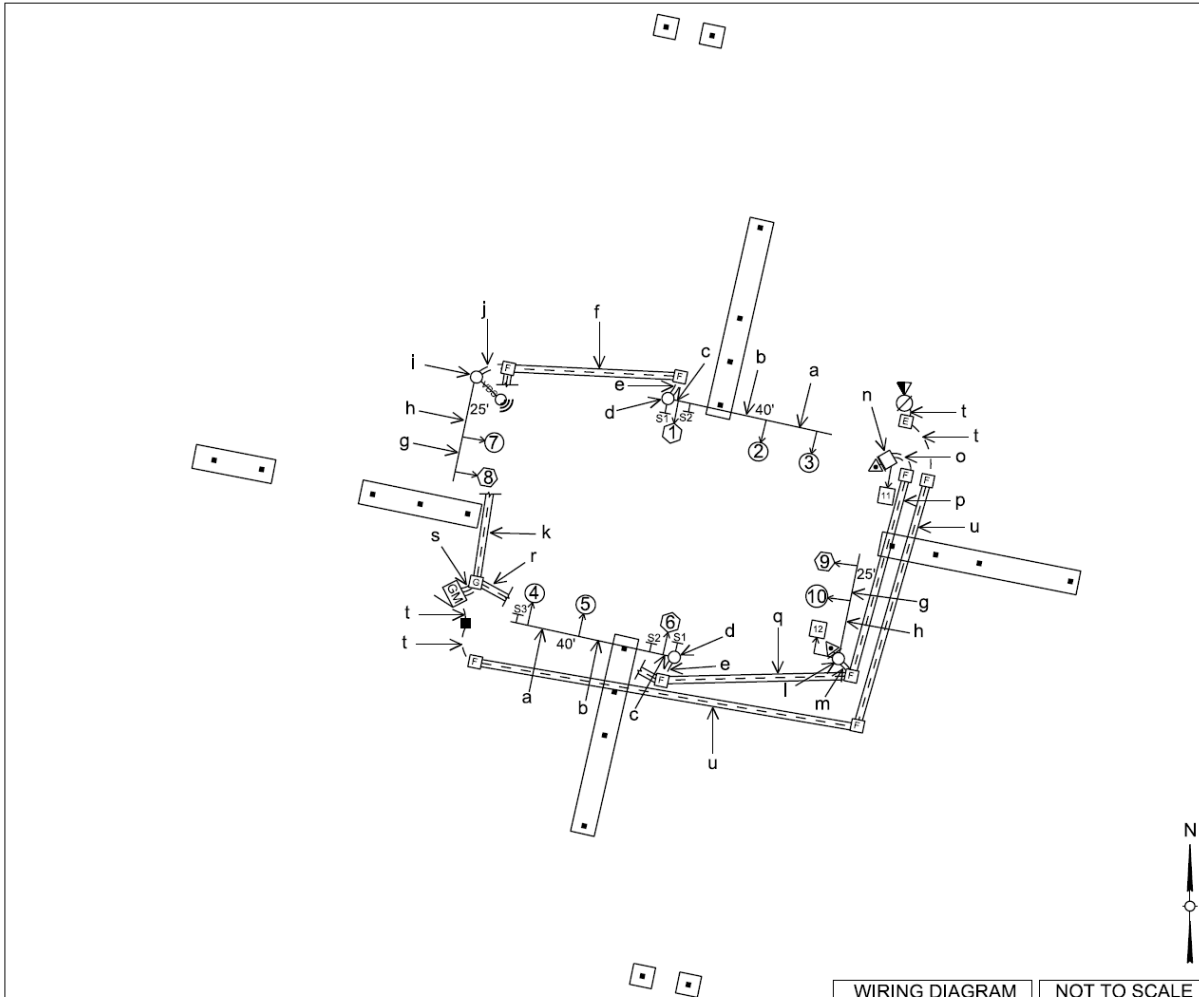

Figure 5-5 Intersection Diagram Page

f. Intersection Wiring Diagram Page

This page is only included in Traffic Signal plans. This page shows the location and type of installations for all signal wiring and hardware. The following information is required on all Intersection Wiring Diagram Pages:

- Mast arms
- Signal Heads
- Signal Detection Devices
- Junction Boxes
- Wire Runs
- Wire Labeling
- Wire Table
- Power Service
- Traffic Signal Inventory number



INTERSECTION: LA 117 @ CORTANA RD.

WIRING DIAGRAM NOT TO SCALE

TSI #: 88-343 PAGE 6 OF 8

- POWER SOURCE
- WOOD POLE
- METAL POLE
- UTILITY POLE
- MAST ARM
- SPAN WIRE
- POLE MOUNTED CABINET & CONTROLLER
- GROUND MOUNTED CABINET & CONTROLLER
- SIGNAL POWER PEDESTAL W/ DISCONNECT
- WIRELESS INTERCONNECT
- WIRELESS VDS
- WIRELESS VDS RECEIVER
- VIDEO DETECTION ZONE & NO.
- VIDEO DETECTION
- LOOP DETECTOR & NO.
- CABLES IN JACKED OR BORED CONDUIT
- TRENCHED AND BACKFILLED CONDUIT
- SIGNAL JUNCTION BOX
- SIGNAL FACE & NO.
- SIGNAL FACE WITH ARROWS & NO.
- PEDESTAL MOUNT SIGNAL & NO.
- PEDESTRIAN SIGNAL & NO.
- PED BUTTON & SIGN
- OVERHEAD SIGN & NO.

WIRING CODE	SIGNAL WIRING TABLE											TYPE					
	WIRING TYPE							INTERCONNECT			CONDUIT						
	VIDEO	LOOP	2CLL	2C	MAG	3C	POWER	3C	6C	10C	7C		Wireless	6 PAIR	FIBER	NO.	SIZE
a									1								OH
b									2								OH
c									2	1							OH
d									2	1							IP
e									2						2	3"	TB
f									2						1	3"	JB
g									1								OH
h									1	1							OH
i					1				1	1							IP
j					1				1	1					2	3"	TB
k					1				1	3					1	3"	JB
l					1				2	1							IP
m					1				2	1					2	3"	TB
n					1				1								IP
o					1				1						2	3"	TB
p					1				1						1	3"	JB
q					2				3	1					1	3"	JB
r					2				3	3					1	3"	JB
s					2	1			4	6					3	3"	TB
t									1						1	2"	TB
u									1						1	3"	JB

OH - OVERHEAD JB - JACK OR BORE TB - TRENCH AND BACKFILL SC - SAW CUT IP - INSIDE POLE
 WIRING CODE TABLE VERSION 3.2

Figure 5-6 Intersection Wiring Diagram Page

g. Intersection Counts and Detection Page

The Intersection Counts and Detection Page includes the most recent intersection counts, all the detection information for the intersection and any additional signal IP addresses. The following information is required for all Intersection Counts and Detection Pages:

- Intersection Name
- Traffic Signal Inventory number
- AM Counts
- Noon Counts
- PM Counts
- Detector Information
 - Detector number
 - Detector delay
 - Detector phase
 - Equipment type
 - Lane number (NB1, NB2, SB1, SB2, etc.)
 - Detection size
 - Number of loops
 - Type of detection (Volume Density or Stopbar)

TRAFFIC SIGNAL INVENTORY (v3.2)						TSI NO. 88-343	
LOUISIANA DEPARTMENT OF TRANSPORTATION AND DEVELOPMENT						PAGE: 7 OF 8	
Intersection: LA 117 @ Cortana Rd.							
TRAFFIC VOLUMES - VPH							
AM PEAK HOUR: 7:00:00 AM to 8:00:00 AM Count Date: 1/17/2020 PHF: 0.94							
MIDDAY PEAK HOUR: 12:00:00 PM to 1:00:00 PM Count Date: 1/17/2020 PHF: 0.94							
PM PEAK HOUR: 4:00:00 PM to 5:00:00 PM Count Date: 1/17/2020 PHF: 0.92							
Detector #	Delay(s)	Extends(s)	Phase	Equipment	Lane #	Size	Type
MZ1			Φ1	Magnetometer	NB1	1-6x50	Stopbar
M2A			Φ2	Magnetometer	SB2	1-6x6	Setback
M2B			Φ2	Magnetometer	SB3	1-6x6	Setback
MZ4	3		Φ4	Magnetometer	WB1	1-6x50	Stopbar
M6A			Φ6	Magnetometer	NB2	1-6x6	Setback
M6B			Φ6	Magnetometer	NB3	1-6x6	Setback
MZ8A	3		Φ8	Magnetometer	EB1	1-6x30	Stopbar
MZ8B			Φ8	Magnetometer	EB1	1-6x20	Stopbar

Figure 5-7 Intersection Counts and Detection Page

h. Preemption Page

The Preemption Page is used to show the needed information for signal preemption. The preemption can be used for emergency vehicles, railroads, and draw bridges. The following information is required for all Preemption Page(s).

- Traffic Signal Inventory number
- Signal Preemption Sequencing
- Clearance Timings
- Termination Timings

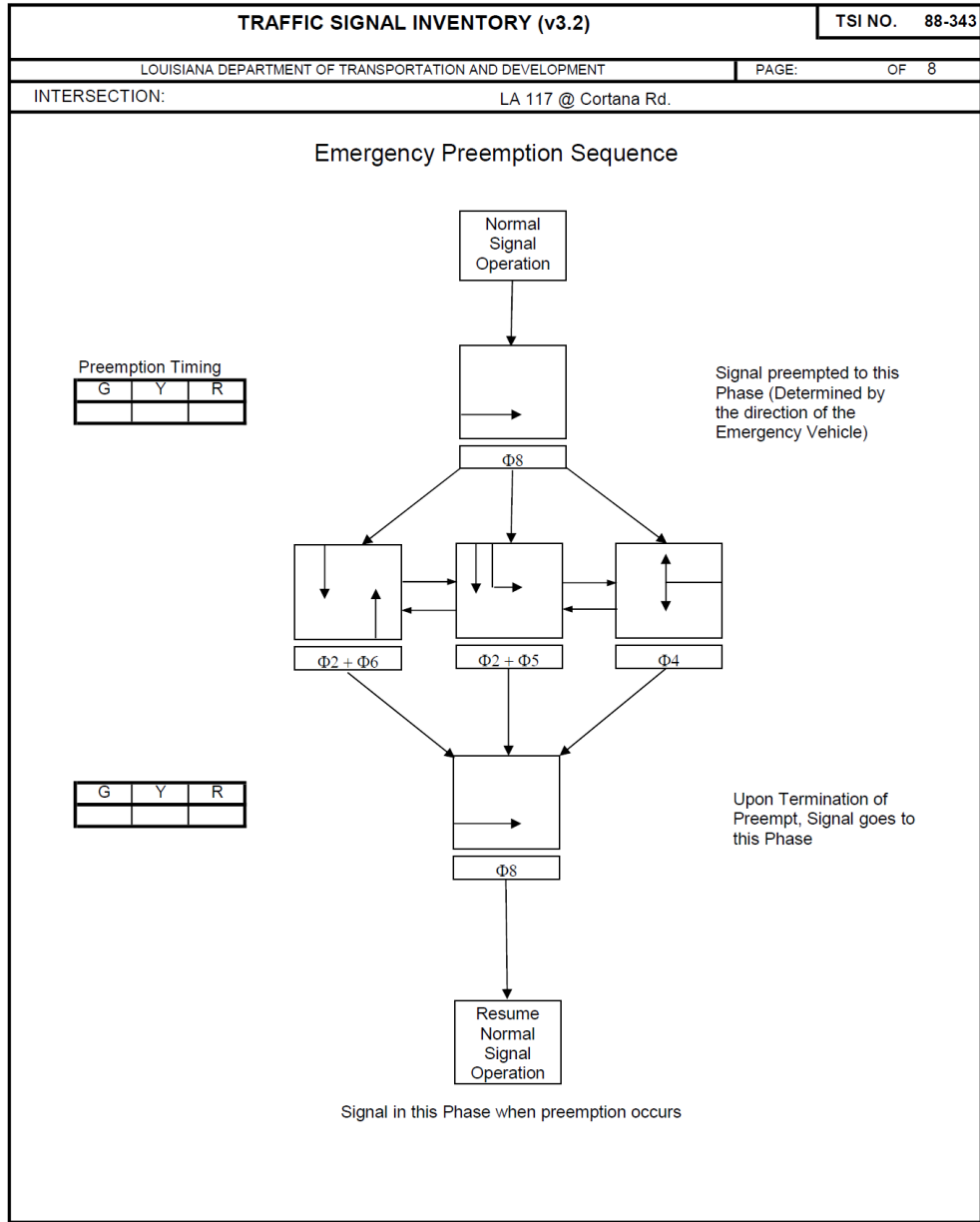

Figure 5-8 Preemption Page

i. Modification and Inspection Record Page

The Modification and Inspection Record Page is used to track any signal modification, adjustments and inspection for an intersection.

TRAFFIC SIGNAL INVENTORY (v3.2)				TSI NO. 88-343	
LOUISIANA DEPARTMENT OF TRANSPORTATION AND DEVELOPMENT				PAGE: 8 OF 8	
INTERSECTION: LA 117 @ Cortana Rd.		CTRL SEC: 343-01	LOGMILE: 1.17		
CITY: Example-Ville		PARISH: Exaplana	LAT: 30.38792	LONG: -91.069035	
SIGNAL TYPE: Volume Density		INTERCONNECT TYPE: GPS & Fiber	REV. DATE: 7/1/2020	INSTALL DATE: 11/15/2001	
SIGNAL WARRANTS:		MAINTAINED BY:	CONTROLLER MANUF: Trafficware	SYSTEM #:	
Traffic Signal Notes Page					
1					
2					
3					
4					
5					
6					
7					
8					
9					
10					
11					
12					
13					
14					
15					
16					
17					
18					
19					
20					
21					
22					
23					
24					
25					
26					
27					
28					
29					
30					
31					
32					
33					
34					
35					
36					
37					
38					
39					
40					

Figure 5-9 Modification and Inspection Record Page

5.2 Traffic Signal Inventory Construction Format

The various full-size signal plan sheets, their format, and contents are described in this section. The following information should be on all signal plan sheets:

- Project Numbers – State, Federal aid and City Parish if applicable
- Parish Name(s)
- Sheet Number
- Schedule of Revisions
- Professional Engineers Stamp

Additionally, all signal plan sheets, excluding the Title Sheet, have title blocks containing the following additional information:

- Project Title
- Intersection or Corridor name (with Hwy. Route numbers)
- Design Organization name
- LADOTD Title (when project is a LADOTD project)
- Design Information (Initials of designer, detailer, checkers)
- Date
- Signal Plan Sheet Number, such as “1 of 3”. Each set of signal plans will begin a new “1 of 3” set. (Separate from the sheet number on the top right corner.)

LA DOTD Title

Project Title

Design Organization name

Intersection or Corridor name

Date

Design Information

Signal Plan Sheet Number

Project number and parish

Sheet number

DESIGNED	CORHARVE HAYES	PARISH	EAST BATON ROUGE
CHECKED	FRANK CORCORAN	FEDERAL PROJECT	H117343
DATE	11/26/2011	STATE PROJECT	H117343
SHEET	1 of 4		

Figure 5-10: Title Block

Information specific to the various signal plan sheets is as follows:

5.2.1 Title Sheet

As previously mentioned, a title sheet is required for “stand alone” signal plans. The Title Sheet contains the following specific information:

- LADOTD Title
- Type of Plans (Urban Systems Project, etc.)
- Project Title
- Location Map – with project location and scale
- Index to sheets
- Survey information – if applicable
- Applicable edition of LA Standard Specifications
- Scale
- Type of Construction
- Approval signatures
- Length of Project Table

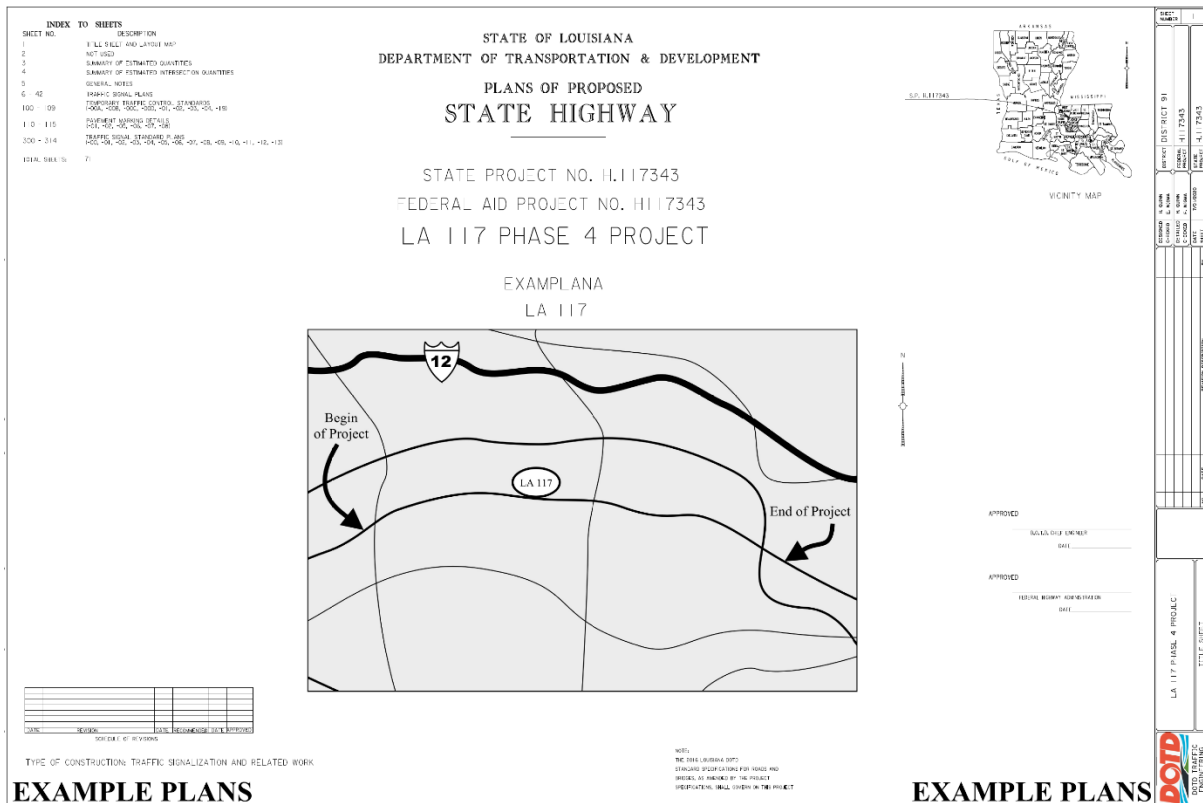

Figure 5-11 Example Title Sheet

b. Summary of Intersection Quantities

This sheet(s) states the quantities for each individual intersection. Figure 5-13 shows an example of the Summary of Estimated Intersection Quantities.

DESCRIPTION	UNITS	LA 117 @ Johnson Blvd	LA 117 @ Kings Blvd	LA 117 @ Missouri Dr	LA 117 @ Buck Blvd	LA 117 @ Cortina Blvd	LA 117 @ Howard Blvd	LA 117 @ LA 104	LA 117 @ LA 47	LA 117 @ Davis St	LA 117 @ Lusk St	LA 117 @ Kelly St	Total Quantities
Removal of Traffic Signal Equipment	LS	LUMP	LUMP	LUMP	LUMP	LUMP	LUMP	LUMP	LUMP	LUMP	LUMP	LUMP	Lump
Removal of Traffic Detectors and Associated Equipment	LS	LUMP	LUMP	LUMP	LUMP	LUMP	LUMP	LUMP	LUMP	LUMP	LUMP	LUMP	Lump
Temporary Signs and Markers	LS	LUMP	LUMP	LUMP	LUMP	LUMP	LUMP	LUMP	LUMP	LUMP	LUMP	LUMP	Lump
Marketers	LS	LUMP	LUMP	LUMP	LUMP	LUMP	LUMP	LUMP	LUMP	LUMP	LUMP	LUMP	Lump
Sign (Type A)	SP	15	0	60	15	31,875	30	60	15	15	15	30	286,875
Unfactored Board Treatment Materials	Dw	0	0	0	0	0	0	0	0	0	0	0	27
Coaching and Hoisting	LJ	263	0	756	150	170	2066	1753	206	915	864	862	6923
Locking or Unlocking for Closure	LJ	684	0	720	210	430	780	763	170	770	716	862	5514
Sign of Pole (Pedestal Pole)	Dw	0	0	0	0	1	0	0	0	0	0	0	1
Sign of Pole (Single Mast Arm, 200)	Dw	0	0	1	0	0	0	0	0	0	0	0	1
Sign of Pole (Single Mast Arm, 250)	Dw	0	0	0	0	2	0	0	0	0	0	0	2
Sign of Pole (Single Mast Arm, 300)	Dw	1	0	0	0	0	2	0	0	0	0	0	3
Sign of Pole (Single Mast Arm, 350)	Dw	1	0	1	2	0	0	2	2	2	0	0	20
Sign of Pole (Single Mast Arm, 400)	Dw	0	0	0	0	2	0	1	0	0	1	0	4
Sign of Pole (Single Mast Arm, 450)	Dw	0	0	2	0	0	0	1	1	0	0	0	4
Sign of Pole (Single Mast Arm, 500)	Dw	2	0	0	1	0	2	0	1	0	2	0	9
Sign of Pole (Dual Mast Arm, 338 Arm 1, 258 Arm 2)	Dw	0	0	0	2	0	0	0	0	0	1	1	3
Sign of Head (3 Section, 12 inch Led Lens, R, Y, G)	Dw	8	0	8	8	6	8	6	6	6	6	6	70
Sign of Head (3 Section, 12 inch Led Lens, R, Y, G, T)	Dw	0	0	2	0	0	0	0	0	0	0	0	2
Sign of Head (3 Sec, 12 inch Led Lens, R, Y, G, T, V, L, G)	Dw	4	0	4	0	0	0	0	0	0	0	0	4
Sign of Head (4 Section, 12 inch Led Lens, R, Y, G, T)	Dw	0	0	0	0	2	0	0	0	0	0	0	2
Sign of Head (4 Section, 12 inch Led Lens, R, Y, G, T, V, L, G)	Dw	2	0	2	1	2	2	1	2	1	1	0	14
Sign of Head (5 Section, 12 inch Led Lens, R, Y, G, T, V, L, G, RT, G)	Dw	1	0	0	1	0	0	0	0	0	0	0	4
Sign of Head (5 Section, 12" Optically Programmed Lens, R, Y, G, T, V, L, G, RT, G)	Dw	0	0	0	0	0	0	2	0	2	0	0	2
Sign of Section	Dw	1	0	1	1	1	1	1	1	1	1	1	10
Sign of Section Pivoted/Disconnect	Dw	1	0	1	1	1	1	1	1	1	1	1	9
Sign of Camera (90 ATC, Type 20/Parish & Insull)	Dw	1	0	1	1	1	1	1	1	1	1	1	10
Video Detector	LJ	0	0	0	288	0	0	0	0	288	288	288	2162
Undersigned Junction Box (Type E)	Dw	1	0	0	3	1	3	3	3	3	2	3	22
Undersigned Junction Box (Type F)	Dw	3	0	3	2	8	3	2	2	2	4	3	32
Undersigned Junction Box (Type G)	Dw	1	0	2	1	2	1	2	1	1	1	1	20
Circuit (12 100V, Schedule 88)	LJ	0	0	0	12	0	12	15	0	15	12	12	78
Circuit (12 400V, Schedule 88)	LJ	186	0	600	410	50	930	72	72	72	72	750	5338
Circuit (12 400V, Schedule 88)	LJ	435	0	144	180	60	404	138	258	138	112	120	1871
Conductor (3, 4/0 awg)	LJ	0	0	0	172	0	0	0	0	915	912	852	3251
Conductor (3, #14 awg)	LJ	0	0	108	78	375	165	167	0	0	0	0	893
Conductor (3, 6 awg) (144 awg)	LJ	246	0	36	130	210	30	72	72	72	208	66	1062
Conductor (3, #14 awg)	LJ	434	0	375	130	900	278	315	130	726	369	96	3218
Conductor (3, #14 awg)	LJ	893	0	869	420	850	775	780	1180	780	500	756	7783
Sign of Support (Foundation, Special Design)	Dw	0	0	0	0	1	0	0	0	0	0	0	1
Sign of Support (Foundation, Special Design) (Foundation)	Dw	4	0	0	2	4	4	4	4	3	3	4	32
Video Detector Cabinet Components	Dw	0	0	0	1	0	0	0	0	1	1	1	4
Video Detector Camera	Dw	0	0	0	4	0	0	0	0	2	2	2	12
Video Camera Cable	LJ	0	0	0	2872	0	0	0	0	2100	0	2380	4272
LED Indicator Countdown Signal Head	Dw	2	0	2	0	0	2	2	2	2	0	2	12
LED Blank Out Sign	Dw	2	0	2	2	0	2	2	2	2	0	0	14
Lot	Dw	1	0	1	1	1	1	1	1	1	1	1	10
Warner's Magnetometer Vehicle Detection System (Components)	Dw	1	0	1	0	1	0	1	0	1	0	0	4
Warner's Magnetometer Vehicle Detection System (Antennas)	Dw	1	0	1	0	1	0	1	0	1	0	0	4
Warner's Magnetometer Vehicle Detection System (Magnetometers)	Dw	36	0	20	0	21	0	0	21	0	0	0	98
Sign of Radar Vehicle Detection Sensor (Long-Range)	Dw	0	0	0	0	0	4	4	0	0	0	0	8
Sign of Radar Vehicle Detection Sensor (Advanced)	Dw	0	0	0	0	0	2	2	0	0	0	0	4
Sign of Radar Vehicle Detection System Cabinet Interface Unit (31)	Dw	0	0	0	0	0	1	1	0	0	0	0	2
Sign of Radar Vehicle Detection Cable	LJ	0	0	0	0	0	5865	1653	0	0	0	0	7518
12-2 Traffic Signal Cabinet (Special Mount)	Dw	1	0	1	1	1	1	1	1	1	1	1	10
2-Way Accessible Pedestrian Pushbutton Transmitters	Dw	2	0	2	2	2	2	2	2	2	2	2	20
2-Way Accessible Pedestrian Pushbutton Cabinet Control	Dw	1	0	1	1	1	1	1	1	1	1	1	10
Fiber Optic Pan Opt K&S, SM, 12 Strand, Furush & Insull	Dw	1	0	1	1	1	1	1	1	1	1	1	10
Fiber Optic Connection, Detail Splice	Dw	4	0	4	4	4	4	4	4	4	4	4	40
Fiber Optic Connection, Termination, Furush & Insull	Dw	4	0	4	4	4	4	4	4	4	4	4	40
Fiber Optic Disp Cable, SM, 12 Strand, Furush & Insull	LJ	190	0	187	142	200	201	169	218	190	300	245	2042
Fiber Optic Patch Cord, SM, 2 Strand, Furush & Insull	Dw	2	0	2	2	2	2	2	2	2	2	2	20
Fiber Optic Connection Patch Panel, Outdoor, Furush & Insull	Dw	1	0	1	1	1	1	1	1	1	1	1	10
Local Ethernet Switch, Furush & Insull	Dw	1	0	1	1	1	1	1	1	1	1	1	10

EXAMPLE PLANS

EXAMPLE PLANS

Figure 5-13 Example Summary of Intersection Quantities Sheet

5.2.3 Signal General Notes Sheet

This sheet contains notes of general nature that apply to all the signalized intersections in the plans. The Signal General Notes Sheet is only required when notes that cover all signals or signal work are needed. It generally includes notes for items from the Louisiana Standard Specifications for Road and Bridges with special emphasis intended for the contractor. A typical signal general notes sheet is shown below in Figure 5-14.

<p>Notes: (The following notes apply to all intersections unless stated otherwise.)</p> <ol style="list-style-type: none"> 1. ALL SIGNAL HEADS SHALL BE MOUNTED WITH THE MINIMUM HEIGHT STATED IN THE TRAFFIC SIGNAL DETAILS UNLESS STATED OTHERWISE. 2. TRAFFIC SIGNAL TIMINGS TO BE PROVIDED AT THE PRE-CONSTRUCTION MEETING BY THE DISTRICT. FOR ALL SIGNALS, THE CONTRACTOR SHALL VERIFY THE TIMINGS WITH THE DISTRICT TRAFFIC OPERATIONS ENGINEER TWO WEEKS PRIOR TO ENTERING THE TIMINGS INTO THE CONTROLLER. 3. LEFT TURN LANES THAT DO NOT HAVE A LEFT TURN PHASE (L, L3, 5, 7) DESIGNATION, USE THE APPROPRIATE SIGNAL HEAD NUMBER TO DESIGNATE WHICH CONNECTIONS SHOULD BE MADE. 4. ALL PROVIDED NEW CONTROLLERS FOR PARTIAL UPGRADES SHALL CONTAIN REQUIRED PROGRAMMING FOR FLASHING YELLOW ARROW OPERATION. 5. A THREE (3) SECOND DELAY SHALL BE PROGRAMMED FOR ALL FLASHING YELLOW ARROW HEADS. 6. ALL ACCESSIBLE PEDESTRIAN PUSHBUTTONS INSTALLED WITHIN 10 FEET OF EACH OTHER ARE TO USE AUDIBLE MESSAGES. 		<table border="1" style="width: 100%; border-collapse: collapse;"> <tr> <td style="font-size: 8px;">SHEET NO.</td> <td style="text-align: center;">5</td> </tr> <tr> <td style="font-size: 8px;">DATE</td> <td></td> </tr> <tr> <td style="font-size: 8px;">DISTRICT</td> <td style="text-align: center;">13</td> </tr> <tr> <td style="font-size: 8px;">PROJECT NO.</td> <td style="text-align: center;">17343</td> </tr> <tr> <td style="font-size: 8px;">SHEET NO.</td> <td style="text-align: center;">13</td> </tr> <tr> <td style="font-size: 8px;">TOTAL SHEETS</td> <td style="text-align: center;">14</td> </tr> <tr> <td style="font-size: 8px;">DATE</td> <td></td> </tr> <tr> <td style="font-size: 8px;">TO: 1000</td> <td></td> </tr> <tr> <td style="font-size: 8px;">DATE</td> <td></td> </tr> <tr> <td style="font-size: 8px;">BY: 135</td> <td></td> </tr> <tr> <td style="font-size: 8px;">DATE</td> <td></td> </tr> <tr> <td style="font-size: 8px;">BY: 135</td> <td></td> </tr> <tr> <td style="font-size: 8px;">DATE</td> <td></td> </tr> <tr> <td colspan="2" style="text-align: center; font-size: 8px;">GENERAL NOTES</td> </tr> <tr> <td colspan="2" style="text-align: center;"> DIVISION OF TRANSPORTATION </td> </tr> </table>	SHEET NO.	5	DATE		DISTRICT	13	PROJECT NO.	17343	SHEET NO.	13	TOTAL SHEETS	14	DATE		TO: 1000		DATE		BY: 135		DATE		BY: 135		DATE		GENERAL NOTES		 DIVISION OF TRANSPORTATION	
SHEET NO.	5																															
DATE																																
DISTRICT	13																															
PROJECT NO.	17343																															
SHEET NO.	13																															
TOTAL SHEETS	14																															
DATE																																
TO: 1000																																
DATE																																
BY: 135																																
DATE																																
BY: 135																																
DATE																																
GENERAL NOTES																																
 DIVISION OF TRANSPORTATION																																
EXAMPLE PLANS	EXAMPLE PLANS																															

Figure 5-14 Example General Notes Sheet

5.2.4 Intersection Sequence and Phase Timing Parameters Sheet

An example of the Intersection Sequence and Phase Timing Sheet is shown in Figure 5-15. The sheet contains both the TSI Intersection Sequence Page and TSI Phase Timing Parameter Page. The requirements for each page are discussed in Sections a and b of this Chapter while information relating to signal timings is discussed in Chapter 3.

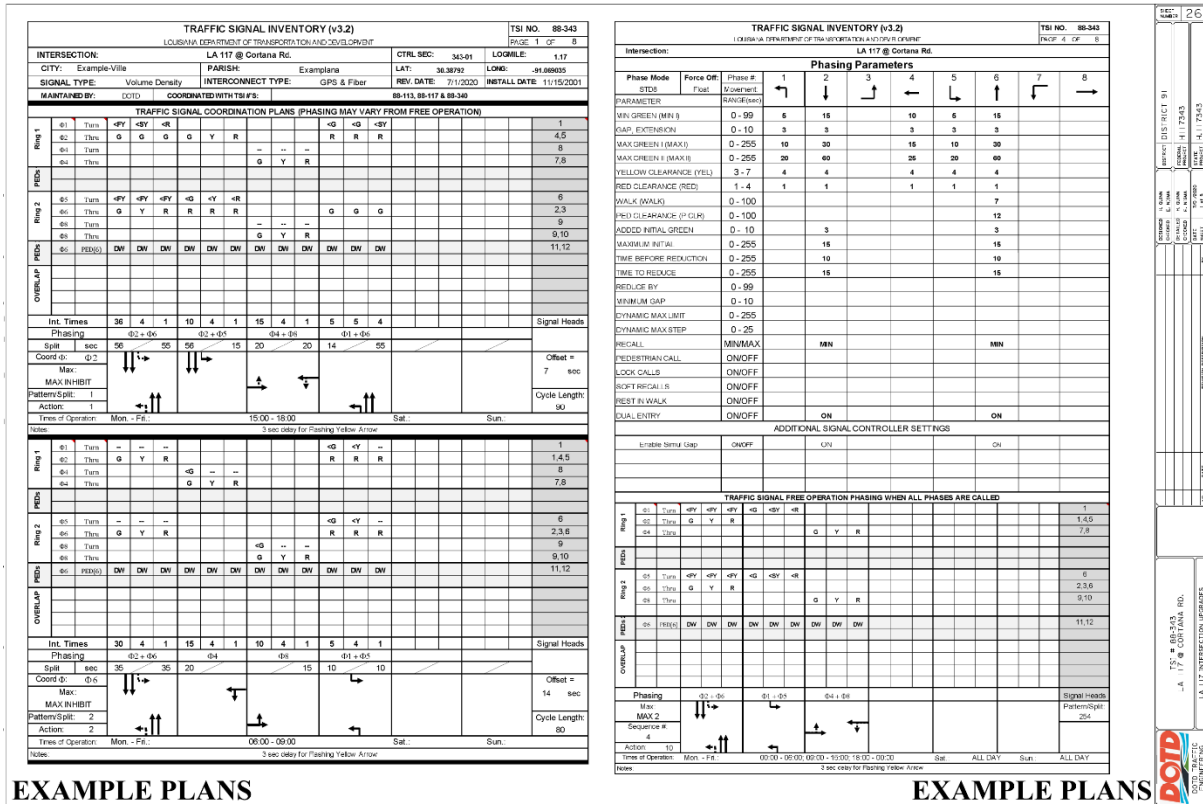

Figure 5-15 Example Intersection Sequence and Phase Timing Parameters Sheet

5.2.5 Intersection Supplemental Sequence and Coordination Sheet

An example of the Intersection Supplemental Sequence and Coordination sheet is shown in Figure 5-16. The sheet contains any additional sequence and coordination pages. Only two pages are to be placed on each sheet. This sheet shall follow the Intersection Sequence and Phase Timing Parameter sheet. The requirements for each page are discussed in Sections a and b of this Chapter while information relating to signal timings is discussed in Chapter 3.

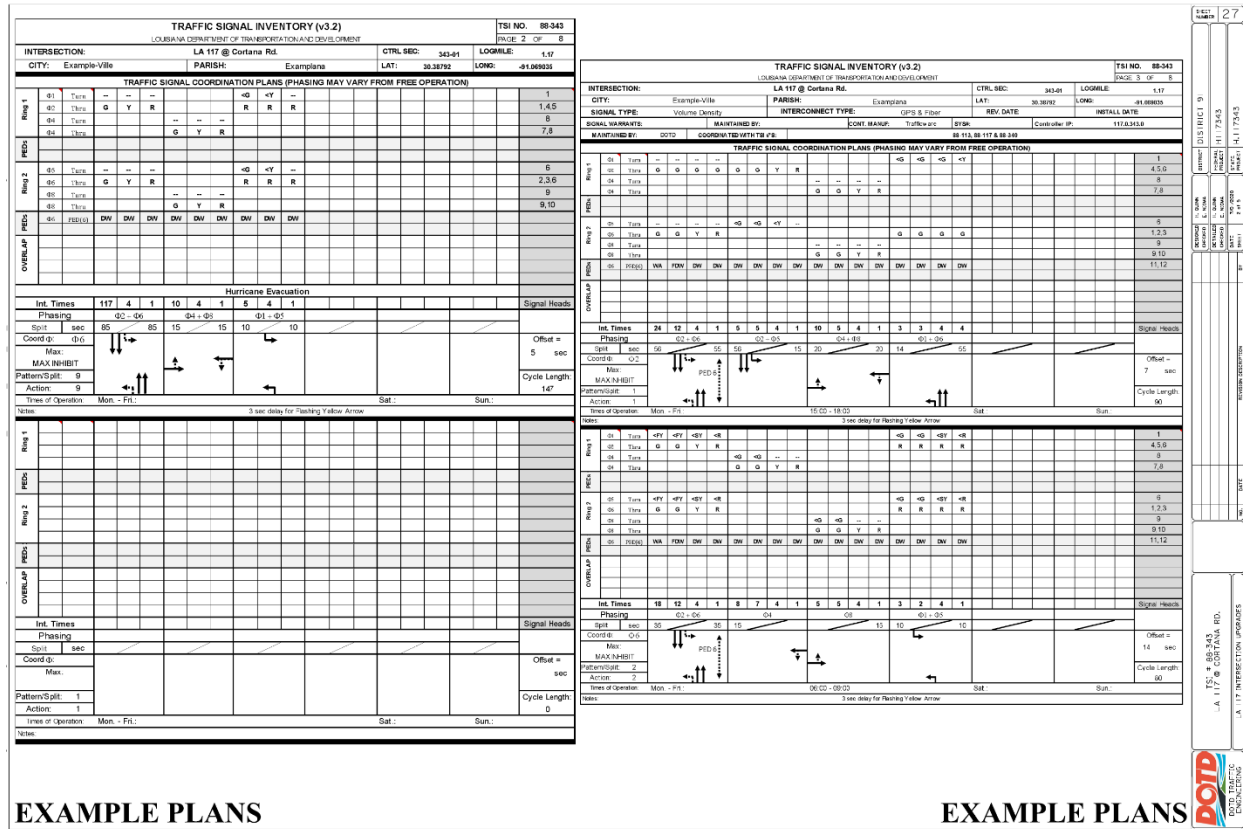

Figure 5-16 Example Intersection Supplemental Sequence and Coordination Sheet

5.2.6 Intersection Diagram and Wiring Sheet

A typical Intersection Diagram and Wiring Sheet is shown in Figure 5-17. The sheet itself contains both TSI Intersection Diagram page and a TSI Wiring Diagram page. The requirements for each page are discussed in Sections e and f of this Chapter while Chapter 4 discusses information relating to signal wiring.

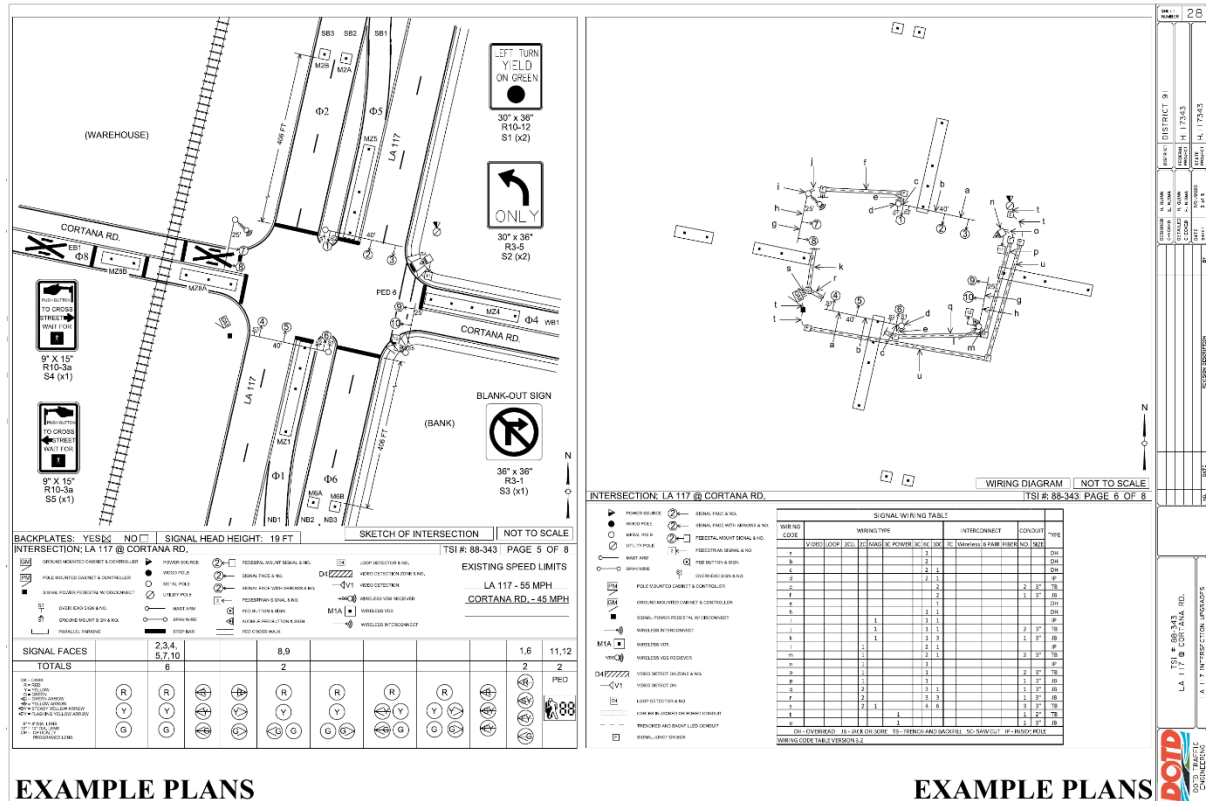

Figure 5-17 Example Signal Layout Sheet

5.2.7 Intersection Count, Detection, and Quantity Sheet

An example of the Signal Count and Quantity Sheet is shown in Figure 5-18. The sheet contains the Intersection Count and Detection Page, Intersection Quantity Table, and any notes specific to the intersection. The requirements for the Intersection Count and Detection Page are discussed in Section g of this Chapter. The Intersection Quantity Table should contain the following information:

- Item Number
- Item Description
- Item Quantity

TRAFFIC SIGNAL INVENTORY (v3.2)		TSI NO. 88-343																									
LOUISIANA DEPARTMENT OF TRANSPORTATION AND DEVELOPMENT																											
Intersection: LA 117 @ Cortana Rd		PAGE: 7 OF 8																									
TRAFFIC VOLUMES -																											
AM PEAK HOUR: 7:00:00 AM to 8:00:00 AM																											
Count Date: 1/17/2020	<table border="1" style="width: 100%; text-align: center;"> <tr> <td>SB</td> <td>60</td> <td>343</td> <td>50</td> <td>WB</td> </tr> <tr> <td>EB</td> <td>36</td> <td></td> <td></td> <td>34</td> </tr> <tr> <td></td> <td>150</td> <td></td> <td></td> <td>264</td> </tr> <tr> <td></td> <td>0</td> <td></td> <td></td> <td>45</td> </tr> <tr> <td>NB</td> <td>70</td> <td>686</td> <td>30</td> <td></td> </tr> </table>		SB	60	343	50	WB	EB	36			34		150			264		0			45	NB	70	686	30	
SB	60	343	50	WB																							
EB	36			34																							
	150			264																							
	0			45																							
NB	70	686	30																								
PHF: 0.94																											
MIDDAY PEAK HOUR: ##### to 1:00:00 PM																											
Count Date: 1/17/2020	<table border="1" style="width: 100%; text-align: center;"> <tr> <td>SB</td> <td>10</td> <td>167</td> <td>22</td> <td>WB</td> </tr> <tr> <td>EB</td> <td>3</td> <td></td> <td></td> <td>13</td> </tr> <tr> <td></td> <td>4</td> <td></td> <td></td> <td>84</td> </tr> <tr> <td></td> <td>3</td> <td></td> <td></td> <td>20</td> </tr> <tr> <td>NB</td> <td>5</td> <td>187</td> <td>50</td> <td></td> </tr> </table>		SB	10	167	22	WB	EB	3			13		4			84		3			20	NB	5	187	50	
SB	10	167	22	WB																							
EB	3			13																							
	4			84																							
	3			20																							
NB	5	187	50																								
PHF: 0.94																											
PM PEAK HOUR: 4:00:00 PM to 5:00:00 PM																											
Count Date: 1/17/2020	<table border="1" style="width: 100%; text-align: center;"> <tr> <td>SB</td> <td>60</td> <td>250</td> <td>25</td> <td>WB</td> </tr> <tr> <td>EB</td> <td>12</td> <td></td> <td></td> <td>17</td> </tr> <tr> <td></td> <td>80</td> <td></td> <td></td> <td>70</td> </tr> <tr> <td></td> <td>25</td> <td></td> <td></td> <td>30</td> </tr> <tr> <td>NB</td> <td>117</td> <td>211</td> <td>15</td> <td></td> </tr> </table>		SB	60	250	25	WB	EB	12			17		80			70		25			30	NB	117	211	15	
SB	60	250	25	WB																							
EB	12			17																							
	80			70																							
	25			30																							
NB	117	211	15																								
PHF: 0.92																											

Detector #	Delay(s)	Extend(s)	Phase	Equipment	Lane #	Size	Type
MZ1			φ1	Magnetometer	NB1	1-6x50	Stopbar
MZ2			φ2	Magnetometer	SB2	1-6x6	Setback
MZ3			φ2	Magnetometer	SB3	1-6x6	Setback
MZ4	3		φ4	Magnetometer	WB1	1-6x50	Stopbar
MZ5			φ5	Magnetometer	NB2	1-6x6	Setback
MZ6			φ5	Magnetometer	NB3	1-6x6	Setback
MZ8A	3		φ8	Magnetometer	EB1	1-6x30	Stopbar
MZ8B			φ8	Magnetometer	EB1	1-6x20	Stopbar

- CONTRACTOR SHALL CONTACT SECTION 45 SIGNAL INSPECTORS AND SCHEDULE A BENCH TEST FOR THE FULLY FUNCTIONAL CABINET INCLUDING CONTROLLER AND MMU UNIT, AT THE SECTION 45 SIGNAL SHOP (7868 TOM DRIVE, BATON ROUGE, 70806) A MINIMUM OF 7 DAYS BEFORE SIGNAL ACTIVATION. APPROVED TSI PLAN SHALL BE PROVIDED IN THE SIGNAL CABINET, AT LEAST ONE TECHNICAL CONTRACTOR REP MAY BE REQUIRED TO BE PRESENT FOR THE BENCH TESTING.
- A MINIMUM OF ONE PERSON WITH A LEVEL 1 TMSA CERTIFICATION IS REQUIRED ON SITE AT ALL TIMES FOR ALL WORK OUTSIDE OF A TRAFFIC SIGNAL CABINET.
- A LEVEL 1 TMSA CERTIFICATION IS REQUIRED FOR ALL WORK INSIDE A TRAFFIC SIGNAL CABINET.
- CONTRACTOR TO PROVIDE CLRTI LED 900 A/C CONTROLLER.
- SEE TRAFFIC SIGNAL STANDARD PLANS (SHEETS 300-314) FOR TERMINAL WIRING CONNECTIONS.

SPQC	NUMBER	DESCRIPTION	UNITS	88-343
726-01	0010	Sign (Type A)	SP	31.875
726-01	0010	Trenching and Backfilling	LF	170
726-01	0010	Backlog or Bedding for Conduit	LF	420
726-04	0004	Signal Pole (Standard Pole)	Fa	1
726-04	0050	Signal Pole (Single Mast Arm, 750)	Fa	2
726-04	0060	Signal Pole (Single Mast Arm, 400)	Fa	2
726-05	0000	Signal Heads (2 Section, 12 inch Led Lens, R, Y, L, G)	Fa	6
726-05	0100	Signal Heads (4 Section, 12 inch Led Lens, R, Y, L, G)	Fa	2
726-05	0130	Signal Heads (4 Section, 12 inch Led Lens, L, R, L, Y, P, Y, L, G)	Fa	2
726-06	0010	Signal Service	Fa	1
726-06	0020	Signal Service (Pedestal Disconnect)	Fa	1
726-06	0010	Signal Controller (900 A/C, Type 2) (Furnish & Install)	Fa	1
726-10	0030	Underground Junction Box (Type E)	Fa	1
726-10	0030	Underground Junction Box (Type F)	Fa	6
726-10	0040	Underground Junction Box (Type G)	Fa	1
726-11	0030	Conduit (2" HDPE, Schedule 80)	LF	50
726-11	0030	Conduit (3" HDPE, Schedule 80)	LF	680
726-12	0204	Conductor (2, #14 awg)	LF	375
726-12	0206	Conductor (2, #16 awg)	LF	230
726-12	0211	Conductor (2, #14 awg)	LF	900
726-12	0214	Conductor (2, #14 awg)	LF	850
726-14	0200	Signal Support (Foundation, 24 inch Minimum Diameter)	Fa	1
726-14	0200	Signal Support (Foundation, 36 inch Minimum Diameter)	Fa	4
726-21	0000	Reflection Patch (Round)	Fa	2
726-23	0000	LED Blank Out Sign	Fa	1
NS-726	0001	GPS	Fa	1
NS-726	0020	Wireless Magnetometer Vehicle Detection System (Cabinet Components)	Fa	1
NS-726	0021	Wireless Magnetometer Vehicle Detection System (Antenna)	Fa	1
NS-726	0022	Wireless Magnetometer Vehicle Detection System (Magnetometer)	Fa	21
NS-726	0030	TS-2 Traffic Signal Cabinet (Ground Mounted)	Fa	1
NS-726	0031	2-Wire Accessible Pedestrian Pushbutton Detection	Fa	2
NS-726	0033	2-Wire Accessible Pedestrian Pushbutton Cabinet Control	Fa	1
NS-ITS	0403	Fiber Optic Fan Out Box, SM, 12 Strand, Furnish & Install	Fa	1
NS-ITS	0410	Fiber Optic Connection, Install, Splice	Fa	4
NS-ITS	0420	Fiber Optic Connection, Termination, Furnish & Install	Fa	4
NS-ITS	0430	Fiber Optic Drop Cable, SM, 12 Strand, Furnish & Install	LF	200
NS-ITS	0430	Fiber Optic Patch Cord, SM, 2 Strand, Furnish & Install	Fa	2
NS-ITS	0442	Fiber Optic Connection Patch Panel, Outdoor, Furnish & Install	Fa	1
NS-ITS	0443	Fiber Optic Connection Patch Panel, Outdoor, Furnish & Install	Fa	1
NS-ITS	0445	Local Ethernet Switch, Furnish & Install	Fa	1

EXAMPLE PLANS

EXAMPLE PLANS

Figure 5-18 Example Traffic Signal Counts/ Notes Sheet

5.2.8 Preemption Sheet

An example Preemption Sheet is shown in Figure 5-19. Only the Signal Preemption page is required on this sheet. The requirements for the Preemption Page are discussed in Section h of this Chapter while information relating to signal preemption is discussed in Chapter 3.

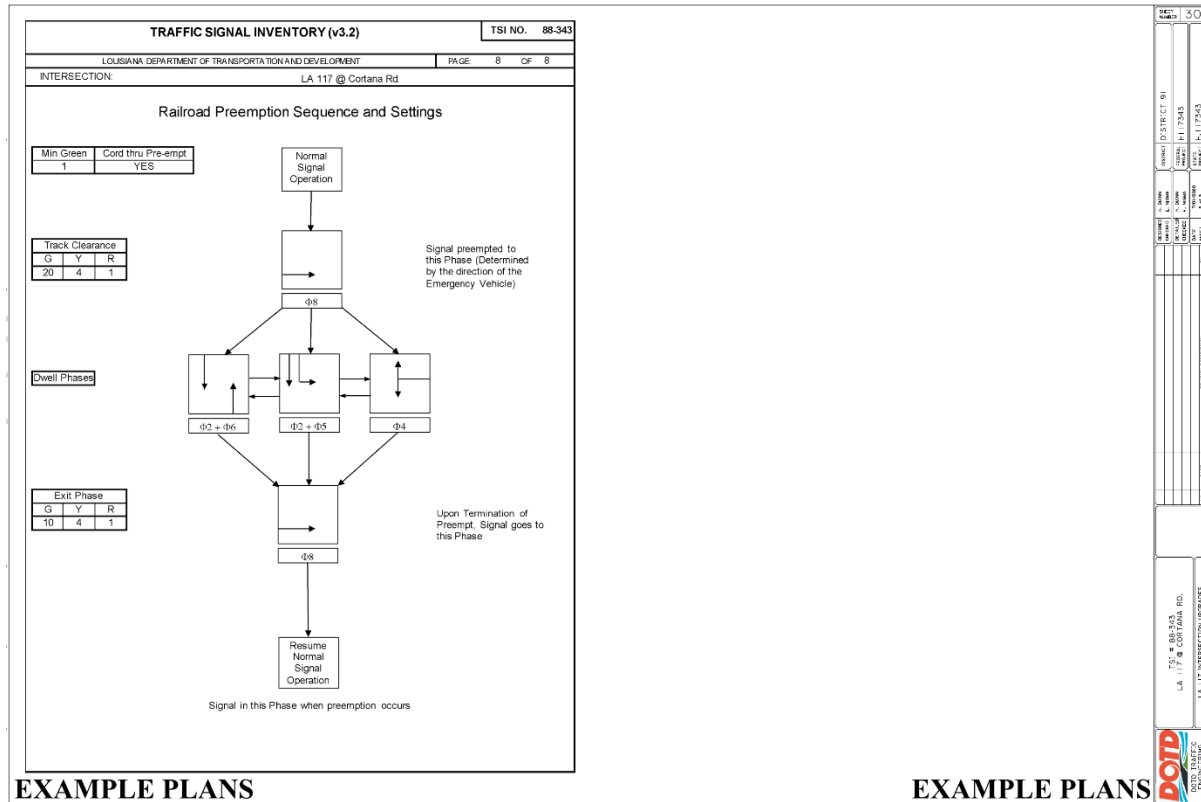

DISTRICT 91	LA 117 @ CORTANA RD.	LA 117 @ CORTANA RD.	LA 117 @ CORTANA RD.

Figure 5-19 Example Preemption Sheet

5.2.9 Signal Interconnect Sheet

If multiple signal locations are coordinated in their operation, a signal interconnect plan sheet is required. The following is required on this plan sheet:

a. Routing Diagram

This diagram shows the general interconnect line routing between all coordinated signal locations in the plans. This routing diagram also designates the size and the approximate locations of junction boxes to be used along this routing, and the location of the signal controller cabinets to be accessed.

b. Notes

The notes accompanying the routing diagram generally cover the following.

- Interconnect Line (Type)
- Conduit (Size, Type, Min. Depth)
- Junction Boxes (Type, Spacing)
- Buried Cable Warning Sign (Size, Legend, Color, Location)

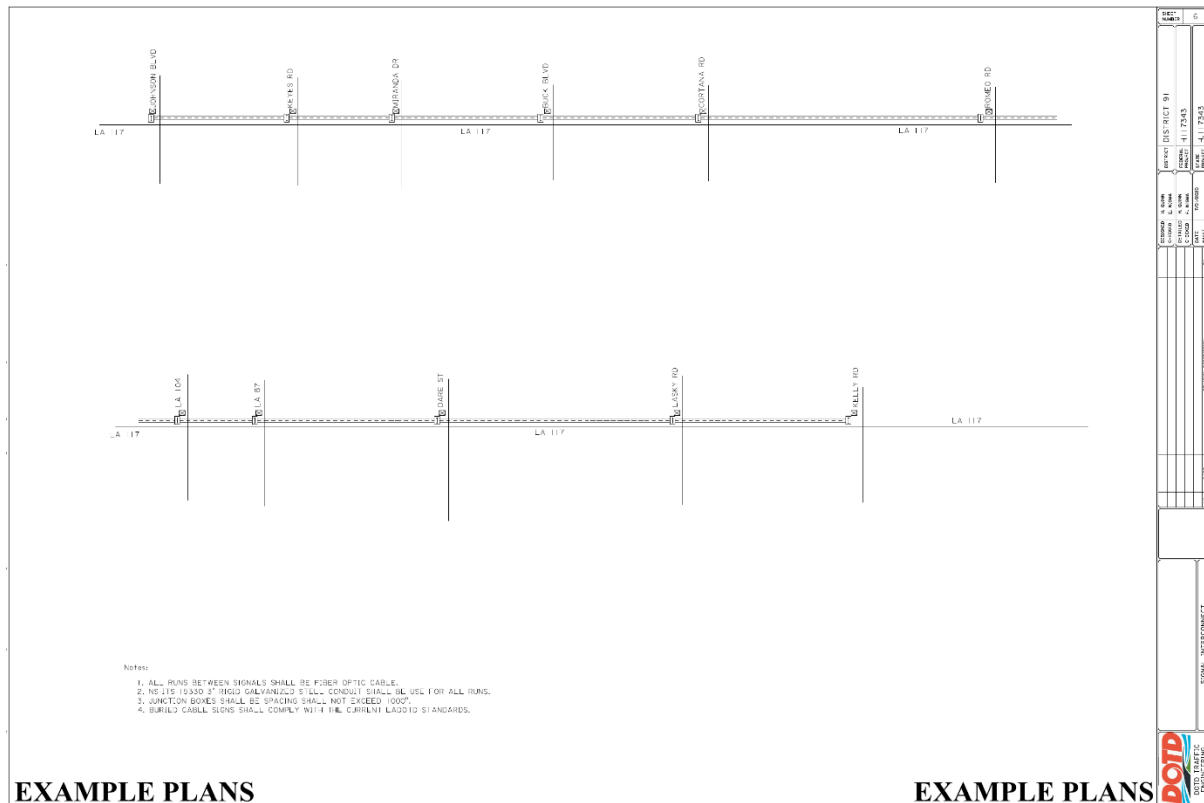

Figure 5-20 Example Signal Interconnect Sheet

5.2.10 Letter Size Intersection Plans

Letter size plans use the TSI pages just as full size plans do. The only change is that only one TSI page is used per plan sheet.

5.3 Additional Signal Plan Information

The following section covers additional signal related information for plans.

5.3.1 Construction Signals

Construction signals are signals or modifications to signals that are required during the course of a construction project. Construction signal plans are to follow the TSI Construction format. Proposed signal timings are to be provided for each sequence of construction stage that requires timing adjustments. TSI Construction format signal layout and wiring will be required for each stage that hardware will need to be adjusted. The TSI Construction format signal layout and wiring sheets shall show in new equipment and adjusted equipment for that stage. This section does not apply to portable traffic signals.

6 Key Terms

Below are key terms mentioned throughout the Traffic Signal Manual:

1. **95% Queue Length** – The 95% queue length is the maximum back of queue with 95th percentile traffic volumes. The 95th volume adjustment accounts for traffic fluctuations.
2. **Actuated** – An actuated signal operates at variable interval lengths in response to the changing traffic flow at the intersection with the use of vehicle detection.
3. **Back of Queue** – The distance between the stop line of a signalized intersection and the farthest vehicle in the upstream queue. The vehicles previously stopped at the front of the queue are counted even if they begin moving.
4. **Change Interval** – The change interval is the yellow plus the red clearance interval.
5. **Demand** – The volume of traffic at an intersection.
6. **Engineering Directives and Standards Manual (EDSM)** – The EDSM consolidates all DOTD directives containing policies, procedures, standards, and guides relating to the administration of the Highway Program which impact the engineering functions of the Department. Waivers must be approved by the Chief Engineer.
7. **Free Operation Timings** – These timings are used when coordination is not being used. When the signal uses free operation timings, the traffic signal is operating on its own demand and timing parameters. This demand is detected by the installed detection.
8. **Fully Actuated** – A fully actuated signal has detection at the stop bar on each approach to the intersection controlling the occurrence and length of the phases.
9. **Manual on Uniform Traffic Control Devices (MUTCD)** - This is a national manual that states the minimum requirements for traffic control.
10. **Max Green Time** – Maximum green time that a phase is allowed.
11. **Min Green Time** – Minimum green time that a phase is guaranteed.
12. **Offset** – The time relationship between coordinated phases.
13. **Peak Hour Observations** – Peak hour observations are to be performed by an Engineer; typically, the Engineer performing the analysis. During peak hour observations, it should be noted if a large queue is forming, the queue doesn't clear the intersection, the sight distance is obstructed, dangers related to railroad crossings exist, signs that the clearance times may be too short, etc.
14. **Pre-timed (Fixed)** – A pre-timed signal uses no detection and operates within a fixed cycle length with preset interval lengths.

15. **Semi-Actuated** – A semi-actuated signal has detection at the stop bar on the minor street approaches and major street left turns only.
16. **Set Back Loops (also known as Volume Density)** – Set back loops are located some distance in advance of the approach stop line. The location of these detectors is based on the safe stopping distance of approaching vehicles, which varies according to the approach speed.

These detectors operate in a presence (locking memory) mode and detect the passage of a vehicle. Set back loops can provide the controller with advance information on vehicles approaching the intersection.
17. **Signal Phase** – A signal phase is a designation for an individual movement that requires its own time. A signal must have at least 2 phases.
18. **Synchro®** – Synchro, a product of Trafficware, is a LADOTD approved software used for signal analysis and optimization.
19. **Timing Plans** – Plans developed to address the fluctuations in demand as required for specific hours of the day.
20. **Traffic Signal Coordination** – Traffic signal coordination occurs when a group of two or more signals are working together so that vehicles traveling through these groups of signals make the least number of stops possible on the main line.
21. **Traffic Signal Controller** – The controller alternates service between conflicting traffic movements. Most traffic signal controllers have a user interface, a central processing unit, external communications connectors, a power supply, and an optional serial communications processor.
22. **Uniform Traffic Demand** – Where traffic variations and timing requirements are predictable or do not vary significantly and can best be accommodated by predetermined timing plans.
23. **VISTRO®** – VISTRO, a product of PTVision, is a LADOTD approved software used for signal analysis and optimization.

7 Table of Figures

Figure 3-1– Protected/Permitted Left Turn/U-Turn Heads..... 18

Figure 3-2 - Intersection Sight Distance - Left Turn from Major Road..... 19

Figure 3-3 - Leading Left Turn with Protected/Permitted Operations..... 20

Figure 3-4 Lagging Left Turn with Protected Operations..... 21

Figure 3-5 Lead-Lag Left Turns with Protected Operations 22

Figure 3-6 Simultaneous Leading Left Turns with Protected/Permitted Operations..... 23

Figure 3-7 Split Phase with Protected Left Turns 24

Figure 3-8 Phase Assignments - 4-Way Intersection (N-S Main St.) 27

Figure 3-9 Phase Assignments - 4-Way Intersection (E-W Main St.) 27

Figure 3-10 Phase Assignments - T-Intersections (N-S Main St. with East Minor St. Approach). 28

Figure 3-11 Phase Assignments - T-Intersections (N-S Main St. with West Minor St. Approach) 29

Figure 3-12 Phase Assignments - T-Intersections (E-W Main St. with North Minor St. Approach)
..... 29

Figure 3-13 Phase Assignments - T-Intersections (E-W Main St. with South Minor St. Approach)
..... 30

Figure 3-14 Gap Reduction Timing..... 37

Figure 3-15 - FYA Indication Order..... 42

Figure 3-16 Typical Railroad Preemption Sequence for 2 Phase Operation 45

Figure 3-17 Track Clearance Worksheet 47

Figure 4-1 Volume Density Loop Placement 55

Figure 4-2 Mast Arm Arrangements: Single Mast Arm..... 66

Figure 4-3 Mast Arm Arrangements: Dual Mast Arm with Curbed Median..... 67

Figure 4-4 Mast Arm Arrangement: Dual Mast Arm 67

Figure 4-5 Mast Arm Arrangements: Combinations Single and Dual Mast Arms 68

Figure 4-6 Span Wire Arrangement: Box Span 71

Figure 4-7 - Span Wire Arrangement: Z Span 72

Figure 4-8 Span Wire Arrangement: Z Span with Curbed Median..... 72

Figure 4-9 Span Wire Arrangement: U-Span 73

Figure 4-10 Traffic Signal Device Wiring Requirements Diagram..... 76

Figure 4-11 Traffic Signal Conduit Sizing..... 77

Figure 4-12 Basic Span Wire Signal Wiring..... 78

Figure 4-13 Basic Mast Arm Wiring 79

Figure 4-14 Basic Conduit Wiring..... 80

Figure 4-15 Full Signal Diagram..... 81

Figure 4-16 Full Signal Wiring Diagram 82

Figure 4-17 Full Signal Wiring Table 82

<i>Figure 4-18 Typical Span Wire Signal Wiring: Examples A & B.....</i>	<i>83</i>
<i>Figure 4-19 Typical Span Wire Signal Wiring: Examples C & D.....</i>	<i>84</i>
<i>Figure 4-20 Typical Span Wire Signal Wiring: Examples E & F</i>	<i>85</i>
<i>Figure 4-21 Typical Span Wire Signal Wiring: Examples G & H</i>	<i>86</i>
<i>Figure 4-22 Typical Span Wire Signal Wiring: Examples I & J.....</i>	<i>87</i>
<i>Figure 4-23 Typical Span Wire Signal Wiring: Example K</i>	<i>88</i>
<i>Figure 4-24 Typical Mast Arm Signal Wiring: Examples A & B</i>	<i>89</i>
<i>Figure 4-25 Typical Mast Arm Signal Wiring: Examples C & D</i>	<i>90</i>
<i>Figure 4-26 Typical Mast Arm Signal Wiring: Examples E & F.....</i>	<i>91</i>
<i>Figure 4-27 Typical Mast Arm Signal Wiring: Examples G & H.....</i>	<i>92</i>
<i>Figure 4-28 Typical Mast Arm Signal Wiring: Examples I & J</i>	<i>93</i>
<i>Figure 4-29 Sign Placement: Single Lane Approach Example 1</i>	<i>102</i>
<i>Figure 4-30 Sign Placement: Single Lane Approach Example 2</i>	<i>103</i>
<i>Figure 4-31 Sign Placement: Single Lane Approach with Separate Left Turn Lane Protected/Permitted Left</i>	<i>104</i>
<i>Figure 4-32 Sign Placement: Single Lane Approach with Separate Left Turn Lane Permitted Left Turn Lane</i>	<i>105</i>
<i>Figure 4-33 Sign Placement: Single Lane Approach with Separate Left Turn Lane Protected Left Turn</i>	<i>106</i>
<i>Figure 4-34 Sign Placement: Two Lane Approach Protected/Permitted Left Turn.....</i>	<i>107</i>
<i>Figure 4-35 Sign Placement: Two Lane Approach with Separate Left Turn Lane Protected/Permitted Left Turn.....</i>	<i>108</i>
<i>Figure 4-36 Sign Placement: Two Lane Approach with Separate Left Turn Lane Protected Left Turn</i>	<i>109</i>
<i>Figure 4-37 Sign Placement: Two Lane Approach with Separate Left & Right Turn Lane Protected/ Permitted Left Turn with Right Turn Overlap</i>	<i>110</i>
<i>Figure 4-38 Sign Placement: Two Lane Approach with Separate Dual Left Turn Lanes Protected Only Dual Left Turn</i>	<i>111</i>
<i>Figure 4-39 Sign Placement: Three Lane Approach with Separate Left Turn Lane Protected Only Left Turn</i>	<i>112</i>
<i>Figure 4-40 Sign Placement: Single Lane Approach No Through Movement</i>	<i>113</i>
<i>Figure 4-41 Sign Placement: Two Lane Approach Protected/Permitted Left Turn</i>	<i>114</i>
<i>Figure 4-42 Sign Placement: Two Lane Approach Dual Left Turns Using Mixed Lanes No Right Turn Overlap</i>	<i>115</i>
<i>Figure 4-43 Sign Placement: Two Lane Approach with Separate Left Turn Lane Protected Left Turn</i>	<i>116</i>
<i>Figure 5-1 Sequence & Coordination Plan Page</i>	<i>121</i>
<i>Figure 5-2 Supplemental Sequence & Coordination Plan Page</i>	<i>122</i>
<i>Figure 5-3 Supplemental Pedestrian Sequence & Coordination Plan Page</i>	<i>123</i>
<i>Figure 5-4 Phasing Timing Parameters Page.....</i>	<i>125</i>
	150

<i>Figure 5-5 Intersection Diagram Page</i>	<i>127</i>
<i>Figure 5-6 Intersection Wiring Diagram Page</i>	<i>129</i>
<i>Figure 5-7 Intersection Counts and Detection Page.....</i>	<i>131</i>
<i>Figure 5-8 Preemption Page.....</i>	<i>133</i>
<i>Figure 5-9 Modification and Inspection Record Page</i>	<i>134</i>
<i>Figure 5-10: Title Block.....</i>	<i>135</i>
<i>Figure 5-11 Example Title Sheet.....</i>	<i>136</i>
<i>Figure 5-12 Example Summary of Estimated Quantities Sheet</i>	<i>137</i>
<i>Figure 5-13 Example Summary of Intersection Quantities Sheet</i>	<i>138</i>
<i>Figure 5-14 Example General Notes Sheet.....</i>	<i>139</i>
<i>Figure 5-15 Example Intersection Sequence and Phase Timing Parameters Sheet</i>	<i>140</i>
<i>Figure 5-16 Example Intersection Supplemental Sequence and Coordination Sheet</i>	<i>141</i>
<i>Figure 5-17 Example Signal Layout Sheet</i>	<i>142</i>
<i>Figure 5-18 Example Traffic Signal Counts/ Notes Sheet.....</i>	<i>143</i>
<i>Figure 5-19 Example Preemption Sheet.....</i>	<i>144</i>
<i>Figure 5-20 Example Signal Interconnect Sheet.....</i>	<i>145</i>

8 Appendix A

This Appendix contains an example TSI Construction Plans.

T:\Traffic Signals\Traffic Signal Manual\Example TSI 3-2\Title and quantity sheets\H.000000 title sheet.dgn 6/29/2020 16:3

INDEX TO SHEETS

SHEET NO.	DESCRIPTION
1	TITLE SHEET AND LAYOUT MAP
2	NOT USED
3	SUMMARY OF ESTIMATED QUANTITIES
4	SUMMARY OF ESTIMATED INTERSECTION QUANTITIES
5	GENERAL NOTES
6 - 42	TRAFFIC SIGNAL PLANS
100 - 109	TEMPORARY TRAFFIC CONTROL STANDARDS (-00A, -00B, -00C, -00D, -01, -02, -03, -04, -19)
110 - 115	PAVEMENT MARKING DETAILS (-01, -02, -05, -06, -07, -08)
300 - 314	TRAFFIC SIGNAL STANDARD PLANS (-00, -01, -02, -03, -04, -05, -06, -07, -08, -09, -10, -11, -12, -13)
TOTAL SHEETS:	71

STATE OF LOUISIANA
DEPARTMENT OF TRANSPORTATION & DEVELOPMENT

PLANS OF PROPOSED
STATE HIGHWAY

STATE PROJECT NO. H.117343
FEDERAL AID PROJECT NO. H117343
LA 117 PHASE 4 PROJECT

EXAMPLANA
LA 117

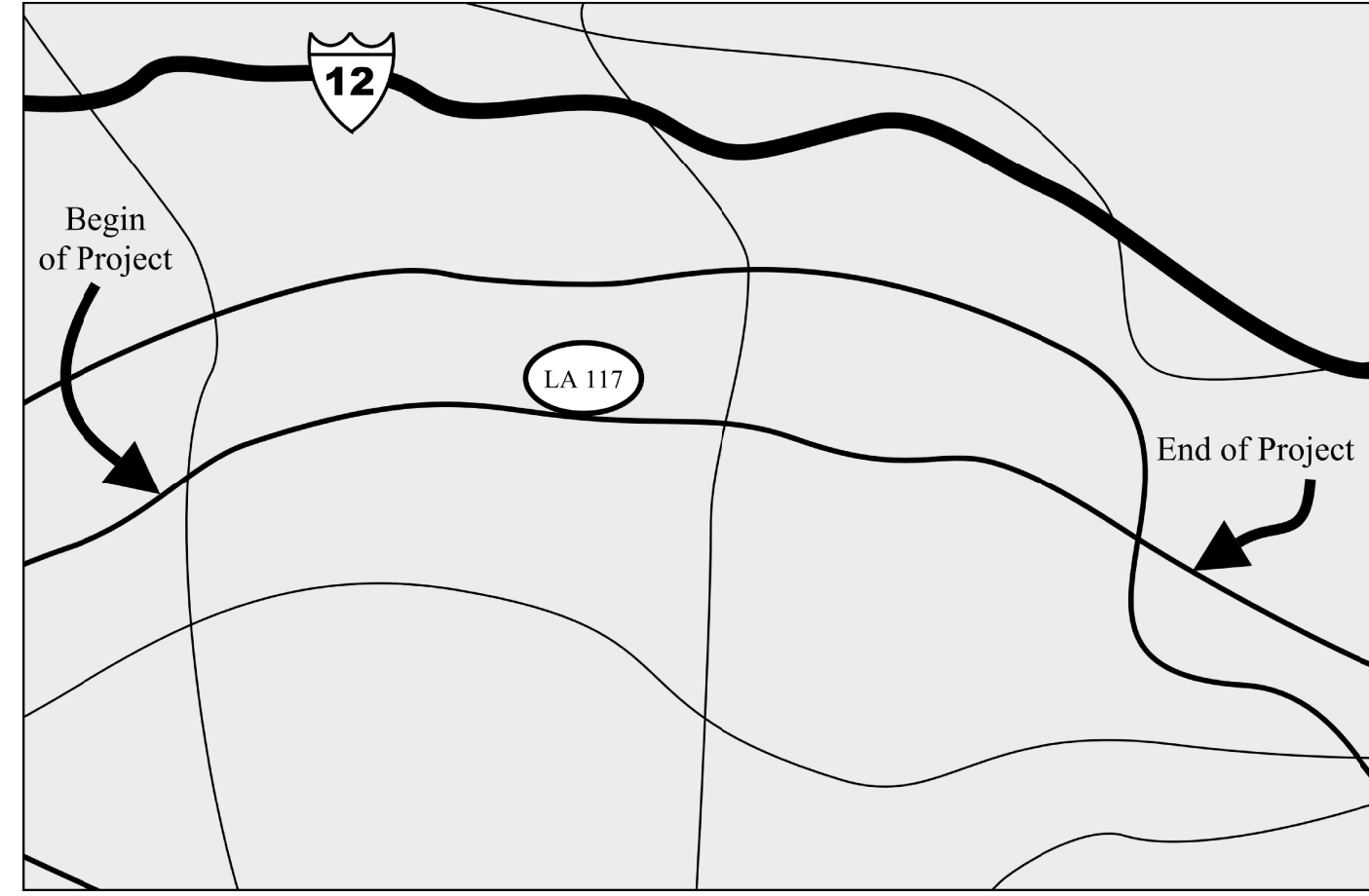

S.P. H.117343



VICINITY MAP

DATE	REVISION	DATE	RECOMMENDED	DATE	APPROVED

SCHEDULE OF REVISIONS

TYPE OF CONSTRUCTION: TRAFFIC SIGNALIZATION AND RELATED WORK

NOTE:
THE 2016 LOUISIANA DOTD
STANDARD SPECIFICATIONS FOR ROADS AND
BRIDGES, AS AMENDED BY THE PROJECT
SPECIFICATIONS, SHALL GOVERN ON THIS PROJECT

APPROVED _____
D.O.T.D. CHIEF ENGINEER
DATE _____

APPROVED _____
FEDERAL HIGHWAY ADMINISTRATION
DATE _____

SHEET NUMBER	1	DISTRICT	DISTRICT 91	FEDERAL PROJECT	H117343	STATE PROJECT	H.117343
DESIGNED	H. QUINN	CHECKED	E. NIGMA	DATE	7/01/2020	SHEET	
DETAILED	H. QUINN	CHECKED	E. NIGMA	NO.		BY	
REVISION DESCRIPTION							
LA 117 PHASE 4 PROJECT							
TITLE SHEET							

EXAMPLE PLANS

EXAMPLE PLANS



DESCRIPTION	UNITS	LA 117 @ Johnson Blvd	LA 117 @ Keyes Blvd	LA 117 @ Miranda Dr	LA 117 @ Buck Blvd	LA 117 @ Cortana Rd	LA 117 @ Romeo Rd	LA 117 @ LA104	LA 117 @ LA 87	LA 117 @ Dare St	LA 117 @ Lasky Rd	LA 117 @ Kelly Rd	Total Quantities
Removal of Traffic Signal Equipment	LS	LUMP	LUMP	LUMP	LUMP	LUMP	LUMP	LUMP	LUMP	LUMP	LUMP	LUMP	Lump
Removal of Traffic Detectors and Associated Equipment	LS	LUMP	LUMP	LUMP	LUMP	LUMP	LUMP	LUMP	LUMP	LUMP	LUMP	LUMP	Lump
Temporary Signs and Barricades	LS	LUMP	LUMP	LUMP	LUMP	LUMP	LUMP	LUMP	LUMP	LUMP	LUMP	LUMP	Lump
Mobilization	LS	LUMP	LUMP	LUMP	LUMP	LUMP	LUMP	LUMP	LUMP	LUMP	LUMP	LUMP	Lump
Sign (Type A)	SF	15	0	60	15	31.875	30	60	15	15	15	30	286.875
ReflectORIZED Raised Pavement Markers	Ea	0	0	0	0	0	0	0	0	0	0	27	27
Trenching and Backfilling	LF	263	0	756	530	170	1086	1253	204	915	864	882	6923
Jacking or Boring for Conduit	LF	463	0	220	210	420	280	283	130	230	216	882	3334
Signal Pole (Pedestal Pole)	Ea	0	0	0	0	1	0	0	0	0	0	0	1
Signal Pole (Single Mast Arm, 20ft)	Ea	0	0	1	0	0	0	0	0	0	0	0	1
Signal Pole (Single Mast Arm, 25ft)	Ea	0	0	0	0	2	0	0	0	0	0	2	4
Signal Pole (Single Mast Arm, 30ft)	Ea	1	0	0	0	0	2	0	0	0	0	0	3
Signal Pole (Single Mast Arm, 35ft)	Ea	1	0	1	2	0	0	2	2	2	0	0	10
Signal Pole (Single Mast Arm, 40ft)	Ea	0	0	0	0	2	0	1	0	0	1	0	4
Signal Pole (Single Mast Arm, 45ft)	Ea	0	0	2	0	0	0	1	1	0	0	0	4
Signal Pole (Single Mast Arm, 50ft)	Ea	2	0	0	1	0	2	0	1	1	0	2	9
Signal Pole (Dual Mast Arm, 35ft-Arm 1, 25ft-Arm 2)	Ea	0	0	0	2	0	0	0	0	0	1	0	3
Signal Heads (3 Section, 12 inch Led Lens, R, Y, G)	Ea	8	0	8	8	6	8	6	6	6	6	8	70
Signal Heads (3 Section, 12 inch Led Lens, R, LT, Y, LT, G)	Ea	0	0	2	0	0	0	0	0	0	0	0	2
Signal Hds (3 Sec, 12 inch Led Lens, LT, R, LT, Y, LT, G)	Ea	4	0	0	0	0	0	0	0	0	0	0	4
Signal Heads (4 Section, 12 inch Led Lens, R, Y, LT, G, G)	Ea	0	0	0	0	2	0	0	0	0	0	0	2
Signal Heads (4 Section, 12 inch Led Lens, LT, R, LT, Y, FLT, Y, LT, G)	Ea	2	0	2	1	2	2	1	2	1	1	0	14
Signal Heads (5 Section, 12 inch Led Lens, R, Y, RT, Y, G, RT, G)	Ea	1	0	0	1	0	0	0	0	0	0	2	4
Signal Heads (5 Section, 12" Optically Programmed Lens, R, Y, RT, Y, G, RT, G)	Ea	0	0	0	0	0	0	0	2	0	0	0	2
Signal Heads (5 Section, 12" Led Lens, R, LT, Y, RT, Y, LT, G, RT, G)	Ea	0	0	0	0	0	1	0	0	0	0	0	1
Signal Service	Ea	1	0	1	1	1	1	1	1	1	1	1	10
Signal Service Pedestal Disconnect	Ea	1	0	1	1	1	1	1	1	1	1	0	9
Signal Controller (980 ATC, Type 2)(Furnish & Install)	Ea	1	0	1	1	1	1	1	1	1	1	1	10
Loop Detector	LF	0	0	0	288	0	0	0	0	288	288	288	1152
Underground Junction Box(Type E)	Ea	1	0	0	3	1	3	3	3	3	2	3	22
Underground Junction Box(Type F)	Ea	3	0	3	2	8	3	2	2	2	4	3	32
Underground Junction Box(Type G)	Ea	1	0	1	1	1	1	1	1	1	1	1	10
Conduit (1" HDPE, Schedule 80)	LF	0	0	0	12	0	12	15	0	15	12	12	78
Conduit (2" HDPE, Schedule 80)	LF	186	0	600	410	50	930	792	72	792	756	750	5338
Conduit (3" HDPE, Schedule 80)	LF	435	0	144	330	680	424	338	250	338	312	120	3371
Conductor (2c, Loop Lead in, imsa 50-2, #14 awg, Twisted Pair, 19 strand)	LF	0	0	0	572	0	0	0	0	915	912	852	3251
Conductor (2c, #14 awg)	LF	0	0	108	78	375	165	167	0	0	0	0	893
Conductor (3c, 6 gauge / #6 awg)	LF	246	0	36	130	210	50	72	72	72	108	66	1062
Conductor (6c, #14 awg)	LF	434	0	375	120	900	278	315	130	276	369	96	3293
Conductor (10c, #14 awg)	LF	893	0	849	420	850	775	780	1180	780	500	756	7783
Signal Support (Foundation, Special Design)	Ea	0	0	0	0	1	0	0	0	0	0	0	1
Signal Support (Foundation, 36 inch Minimum Diameter)	Ea	4	0	0	2	4	4	4	4	3	3	4	32
Video Detection Cabinet Components	Ea	0	0	0	1	0	0	0	0	1	1	1	4
Video Detection Camera	Ea	0	0	0	4	0	0	0	0	2	2	4	12
Video Camera Cable	LF	0	0	0	1872	0	0	0	0	1100	0	1300	4272
LED Pedestrian Countdown Signal Head	Ea	2	0	2	0	0	2	2	2	0	2	0	12
LED Blank Out Sign	Ea	2	0	2	2	0	2	2	2	2	0	0	14
GPS	Ea	1	0	1	1	1	1	1	1	1	1	1	10
Wireless Magnetometer Vehicle Detection System (Cabinet Components)	Ea	1	0	1	0	1	0	0	1	0	0	0	4
Wireless Magnetometer Vehicle Detection System (Antennas)	Ea	1	0	1	0	1	0	0	1	0	0	0	4
Wireless Magnetometer Vehicle Detection System (Magnetometers)	Ea	36	0	20	0	21	0	0	21	0	0	0	98
Signal Radar Vehicle Detection Sensor (Stop Bar)	Ea	0	0	0	0	0	4	4	0	0	0	0	8
Signal Radar Vehicle Detection Sensor (Advanced)	Ea	0	0	0	0	0	2	2	0	0	0	0	4
Signal Radar Vehicle Detection System Cabinet Interface Unit (CIU)	Ea	0	0	0	0	0	1	1	0	0	0	0	2
Signal Radar Vehicle Detection (Cable)	LF	0	0	0	0	0	1865	1653	0	0	0	0	3518
TS-2 Traffic Signal Cabinet (Ground Mounted)	Ea	1	0	1	1	1	1	1	1	1	1	1	10
2-Wire Accessible Pedestrian Pushbutton Detectors	Ea	2	0	2	2	2	2	2	2	2	2	2	20
2-Wire Accessible Pedestrian Pushbutton Cabinet Control	Ea	1	0	1	1	1	1	1	1	1	1	1	10
Fiber Optic Fan Out Kits, SM, 12 Strand, Furnish & Install	Ea	1	0	1	1	1	1	1	1	1	1	1	10
Fiber Optic Connection, Install, Splice	Ea	4	0	4	4	4	4	4	4	4	4	4	40
Fiber Optic Connection, Termination, Furnish & Install	Ea	4	0	4	4	4	4	4	4	4	4	4	40
Fiber Optic Drop Cable, SM, 12 Strand, Furnish & Install	LF	190	0	187	142	200	201	169	218	190	300	245	2042
Fiber Optic Patch Cord, SM, 2 Strand, Furnish & Install	Ea	2	0	2	2	2	2	2	2	2	2	2	20
Fiber Optic Connection Patch Panel, Outdoor, Furnish & Install	Ea	1	0	1	1	1	1	1	1	1	1	1	10
Local Ethernet Switch, Furnish & Install	Ea	1	0	1	1	1	1	1	1	1	1	1	10

SHEET NUMBER	4
DISTRICT	DISTRICT 91
FEDERAL PROJECT	H 117343
STATE PROJECT	H 117343
DESIGNED	H. QUINN
CHECKED	E. NIGMA
DETAILED	H. QUINN
CHECKED	E. NIGMA
DATE	7/01/2020
SHEET	
NO.	
DATE	
BY	
REVISION DESCRIPTION	
SUMMARY OF ESTIMATED INTERSECTION QUANTITIES	



Notes: (The following notes apply to all intersections unless stated otherwise.)

1. ALL SIGNAL HEADS SHALL BE MOUNTED WITH THE MINIMUM HEIGHT STATED IN THE TRAFFIC SIGNAL DETAILS UNLESS STATED OTHERWISE.
2. TRAFFIC SIGNAL TIMINGS TO BE PROVIDED AT THE PRECONSTRUCTION MEETING BY THE DISTRICT. FOR ALL SIGNALS, THE CONTRACTOR SHALL VERIFY THE TIMINGS WITH THE DISTRICT TRAFFIC OPERATIONS ENGINEER TWO WEEK PRIOR TO ENTERING THE TIMINGS INTO THE CONTROLLER.
3. LEFT TURN LANES THAT DO NOT HAVE A LEFT TURN PHASE (I.E. 1,3,5,7) DESIGNATION, USE THE APPROPRIATE SIGNAL HEAD NUMBER TO DESIGNATE WHERE CONNECTIONS SHOULD BE MADE.
4. ALL PROVIDED NEW CONTROLLERS FOR PARTIAL UPGRADES SHALL CONTAIN REQUIRED PROGRAMMING FOR FLASHING YELLOW ARROW OPERATION.
5. A THREE (3) SECOND DELAY SHALL BE PROGRAMMED FOR ALL FLASHING YELLOW ARROW HEADS.
6. ALL ACCESSIBLE PEDESTRIAN PUSHBUTTONS INSTALLED WITHIN 10 FEET OF EACH OTHER ARE TO USE AUDIBLE MESSAGES.

DESIGNED CHECKED		H. QUINN E. NIGMA	DISTRICT	DISTRICT 91	SHEET NUMBER	5
DETAILED CHECKED		H. QUINN E. NIGMA	FEDERAL PROJECT	H117343		
DATE		7/01/2020	STATE PROJECT	H.117343		
NO.		REVISION DESCRIPTION		BY		
DATE						
GENERAL NOTES						



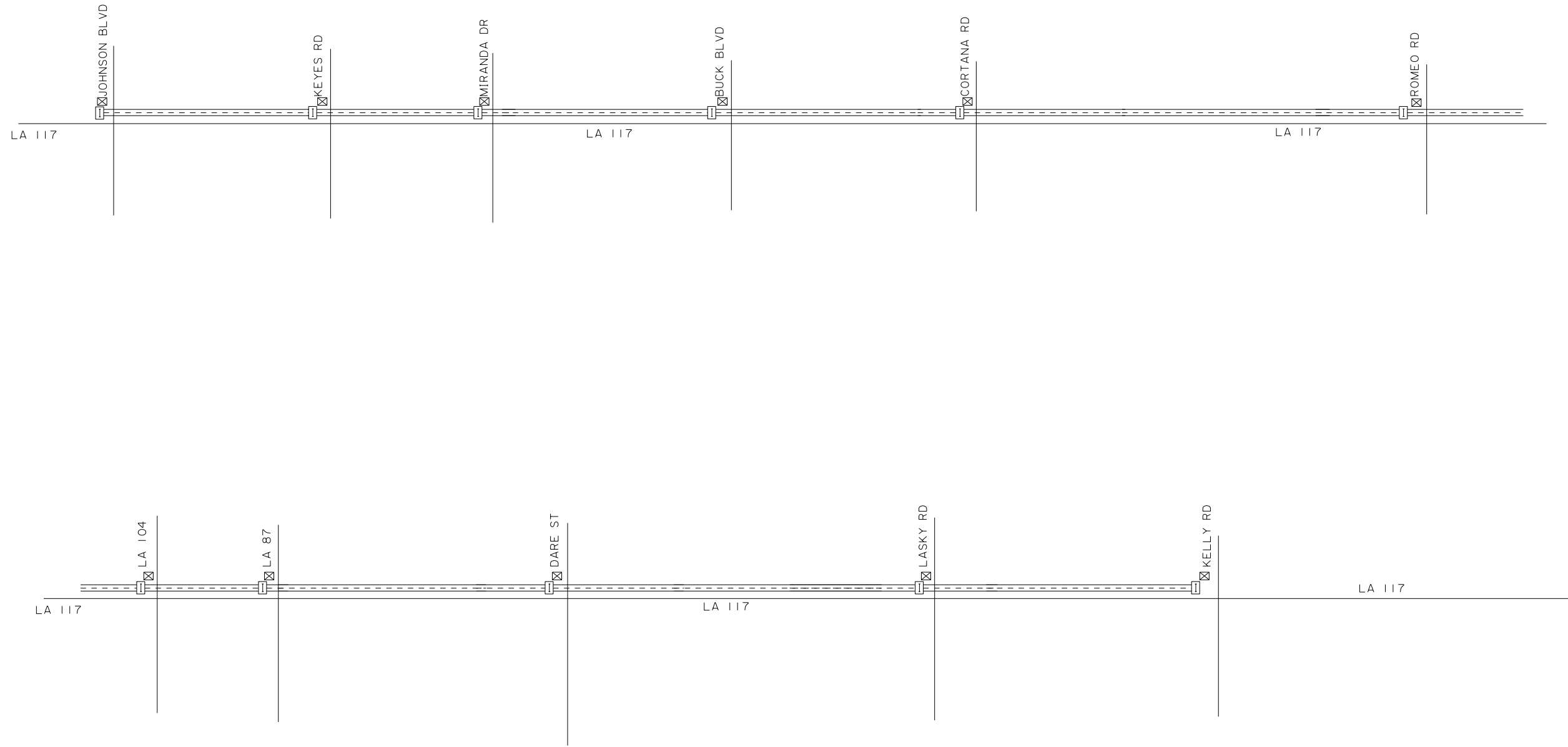

Notes:

1. ALL RUNS BETWEEN SIGNALS SHALL BE FIBER OPTIC CABLE.
2. NS-ITS-15330 3" RIGID GALVANIZED STEEL CONDUIT SHALL BE USE FOR ALL RUNS.
3. JUNCTION BOXES SHALL BE SPACING SHALL NOT EXCEED 1000".
4. BURIED CABLE SIGNS SHALL COMPLY WITH THE CURRENT LADOTD STANDARDS.

EXAMPLE PLANS

EXAMPLE PLANS



SIGNAL INTERCONNECT

NO.	DATE	REVISION DESCRIPTION	BY

DESIGNED	H. QUINN
CHECKED	E. NIGMA
DETAILED	H. QUINN
CHECKED	E. NIGMA
DATE	7/01/2020
SHEET	

DISTRICT	DISTRICT 91
FEDERAL PROJECT	H117343
STATE PROJECT	H.117343
SHEET NUMBER	01

TRAFFIC SIGNAL INVENTORY (v3.2)													TSI NO. 88-343		
LOUISIANA DEPARTMENT OF TRANSPORTATION AND DEVELOPMENT													PAGE 1 OF 8		
INTERSECTION: LA 117 @ Cortana Rd.				CTRL SEC: 343-01		LOGMILE: 1.17									
CITY: Example-Ville			PARISH: Exaplana			LAT: 30.38792		LONG: -91.069035							
SIGNAL TYPE: Volume Density			INTERCONNECT TYPE: GPS & Fiber			REV. DATE: 7/1/2020		INSTALL DATE: 11/15/2001							
MAINTAINED BY: DOTD		COORDINATED WITH TSI #'S: 88-113, 88-117 & 88-340													
TRAFFIC SIGNAL COORDINATION PLANS (PHASING MAY VARY FROM FREE OPERATION)															
Ring 1	Φ1	Turn	<FY	<SY	<R						<G	<G	<SY		1
	Φ2	Thru	G	G	G	G	Y	R			R	R	R		4,5
	Φ4	Turn							--	--					8
	Φ4	Thru							G	Y	R				7,8
Ring 2	Φ5	Turn	<FY	<FY	<FY	<G	<Y	<R							6
	Φ6	Thru	G	Y	R	R	R	R			G	G	G		2,3
	Φ8	Turn							--	--					9
	Φ8	Thru							G	Y	R				9,10
OVERLAP	Φ6	PED(6)	DW	DW	DW	DW	DW	DW	DW	DW	DW	DW	DW	DW	11,12
	Signal Heads														
Int. Times			36	4	1	10	4	1	15	4	1	5	5	4	
Phasing			Φ2 + Φ6			Φ2 + Φ5			Φ4 + Φ8			Φ1 + Φ6			
Split sec			56	55	56	15	20	20	14	55					
Coord Φ:			Φ2			Φ4			Φ8			Φ6			Offset = 7 sec
Max:															
MAX INHIBIT															
Pattern/Split:			1												Cycle Length: 90
Action:			1												
Times of Operation:			Mon. - Fri.: 15:00 - 18:00				Sat.: 15:00 - 18:00				Sun.: 15:00 - 18:00				
Notes: 3 sec delay for Flashing Yellow Arrow															
Ring 1	Φ1	Turn	--	--	--						<G	<Y	--		1
	Φ2	Thru	G	Y	R						R	R	R		1,4,5
	Φ4	Turn				<G	--	--							8
	Φ4	Thru				G	Y	R							7,8
Ring 2	Φ5	Turn	--	--	--						<G	<Y	--		6
	Φ6	Thru	G	Y	R						R	R	R		2,3,6
	Φ8	Turn							<G	--	--				9
	Φ8	Thru							G	Y	R				9,10
OVERLAP	Φ6	PED(6)	DW	DW	DW	DW	DW	DW	DW	DW	DW	DW	DW	DW	11,12
	Signal Heads														
Int. Times			30	4	1	15	4	1	10	4	1	5	4	1	
Phasing			Φ2 + Φ6			Φ4			Φ8			Φ1 + Φ5			
Split sec			35	35	20	15			10			10			
Coord Φ:			Φ6			Φ4			Φ8			Φ5			Offset = 14 sec
Max:															
MAX INHIBIT															
Pattern/Split:			2												Cycle Length: 80
Action:			2												
Times of Operation:			Mon. - Fri.: 06:00 - 09:00				Sat.: 06:00 - 09:00				Sun.: 06:00 - 09:00				
Notes: 3 sec delay for Flashing Yellow Arrow															

TRAFFIC SIGNAL INVENTORY (v3.2)													TSI NO. 88-343		
LOUISIANA DEPARTMENT OF TRANSPORTATION AND DEVELOPMENT													PAGE 4 OF 8		
Intersection: LA 117 @ Cortana Rd.															
Phasing Parameters															
Phase Mode	Force Off:	Phase #:	1	2	3	4	5	6	7	8					
STD8	Float	Movement:	←	↓	↗	←	↘	↑	↖	→					
PARAMETER		RANGE(sec)													
MIN GREEN (MIN I)		0 - 99	5	15		10	5	15							
GAP, EXTENSION		0 - 10	3	3		3	3	3							
MAX GREEN I (MAX I)		0 - 255	10	30		15	10	30							
MAX GREEN II (MAX II)		0 - 255	20	60		25	20	60							
YELLOW CLEARANCE (YEL)		3 - 7	4	4		4	4	4							
RED CLEARANCE (RED)		1 - 4	1	1		1	1	1							
WALK (WALK)		0 - 100						7							
PED CLEARANCE (P CLR)		0 - 100						12							
ADDED INITIAL GREEN		0 - 10		3				3							
MAXIMUM INITIAL		0 - 255		15				15							
TIME BEFORE REDUCTION		0 - 255		10				10							
TIME TO REDUCE		0 - 255		15				15							
REDUCE BY		0 - 99													
MINIMUM GAP		0 - 10													
DYNAMIC MAX LIMIT		0 - 255													
DYNAMIC MAX STEP		0 - 25													
RECALL		MIN/MAX		MIN				MIN							
PEDESTRIAN CALL		ON/OFF													
LOCK CALLS		ON/OFF													
SOFT RECALLS		ON/OFF													
REST IN WALK		ON/OFF													
DUAL ENTRY		ON/OFF		ON				ON							
ADDITIONAL SIGNAL CONTROLLER SETTINGS															
Enable Simul Gap		ON/OFF		ON				ON							
TRAFFIC SIGNAL FREE OPERATION PHASING WHEN ALL PHASES ARE CALLED															
Ring 1	Φ1	Turn	<FY	<FY	<FY	<G	<SY	<R							1
	Φ2	Thru	G	Y	R						G	Y	R		1,4,5
	Φ4	Thru													7,8
	Signal Heads														
Ring 2	Φ5	Turn	<FY	<FY	<FY	<G	<SY	<R							6
	Φ6	Thru	G	Y	R						G	Y	R		2,3,6
	Φ8	Thru													9,10
	Signal Heads														
OVERLAP	Φ6	PED(6)	DW	DW	DW	DW	DW	DW	DW	DW	DW	DW	DW	DW	11,12
	Signal Heads														
Int. Times			30	4	1	15	4	1	10	4	1	5	4	1	
Phasing			Φ2 + Φ6			Φ4			Φ8			Φ1 + Φ5			
Split sec			35	35	20	15			10			10			
Coord Φ:			Φ6			Φ4			Φ8			Φ5			Offset = 14 sec
Max:															
MAX INHIBIT															
Pattern/Split:			2												Cycle Length: 254
Action:			10												
Times of Operation:			Mon. - Fri.: 00:00 - 06:00; 09:00 - 15:00; 18:00 - 00:00				Sat.: ALL DAY				Sun.: ALL DAY				
Notes: 3 sec delay for Flashing Yellow Arrow															

EXAMPLE PLANS

EXAMPLE PLANS

SHEET NUMBER	26
DISTRICT	DISTRICT 91
FEDERAL PROJECT	H 117343
STATE PROJECT	H. 117343
DESIGNED	H. QUINN
CHECKED	E. NIGMA
DETAILED	H. QUINN
CHECKED	E. NIGMA
DATE	7/01/2020
SHEET	1 of 5
NO.	DATE
BY	REVISION DESCRIPTION
TSI # 88-343 LA 117 @ CORTANA RD. LA 117 INTERSECTION UPGRADES	
DOTD LOUISIANA DEPARTMENT OF TRANSPORTATION AND DEVELOPMENT ENGINEERING	

TRAFFIC SIGNAL INVENTORY (v3.2)												TSI NO. 88-343																																																																																																																																																													
LOUISIANA DEPARTMENT OF TRANSPORTATION AND DEVELOPMENT												PAGE 2 OF 8																																																																																																																																																													
INTERSECTION: LA 117 @ Cortana Rd.				CTRL SEC: 343-01		LOGMILE: 1.17																																																																																																																																																																			
CITY: Example-Ville		PARISH: Exaplana		LAT: 30.38792		LONG: -91.069035																																																																																																																																																																			
TRAFFIC SIGNAL COORDINATION PLANS (PHASING MAY VARY FROM FREE OPERATION)																																																																																																																																																																									
Ring 1	Φ1	Turn	-	-	-					<G	<Y	-		1																																																																																																																																																											
	Φ2	Thru	G	Y	R					R	R	R		1,4,5																																																																																																																																																											
	Φ4	Turn				--	--	--						8																																																																																																																																																											
	Φ4	Thru				G	Y	R						7,8																																																																																																																																																											
PEDs																																																																																																																																																																									
Ring 2	Φ5	Turn	-	-	-					<G	<Y	-		6																																																																																																																																																											
	Φ6	Thru	G	Y	R					R	R	R		2,3,6																																																																																																																																																											
	Φ8	Turn				--	--	--						9																																																																																																																																																											
	Φ8	Thru				G	Y	R						9,10																																																																																																																																																											
PEDs																																																																																																																																																																									
OVERLAP																																																																																																																																																																									
<table border="1"> <thead> <tr> <th colspan="14">Hurricane Evacuation</th> </tr> <tr> <th colspan="2">Int. Times</th> <td>117</td> <td>4</td> <td>1</td> <td>10</td> <td>4</td> <td>1</td> <td>5</td> <td>4</td> <td>1</td> <td colspan="3"></td> <td>Signal Heads</td> </tr> <tr> <th colspan="2">Phasing</th> <td colspan="2">Φ2 + Φ6</td> <td colspan="2">Φ4 + Φ8</td> <td colspan="2">Φ1 + Φ5</td> <td colspan="6"></td> <td></td> </tr> <tr> <th>Split</th> <th>sec</th> <td>85</td> <td>85</td> <td>15</td> <td>15</td> <td>10</td> <td>10</td> <td colspan="6"></td> <td></td> </tr> <tr> <th colspan="2">Coord Φ:</th> <td colspan="2">Φ6</td> <td colspan="2"></td> <td colspan="2"></td> <td colspan="6"></td> <td>Offset = 5 sec</td> </tr> <tr> <th colspan="2">Max:</th> <td colspan="12"></td> <td></td> </tr> <tr> <th colspan="2">MAX INHIBIT</th> <td colspan="12"></td> <td></td> </tr> <tr> <th colspan="2">Pattern/Split:</th> <td colspan="2">9</td> <td colspan="2"></td> <td colspan="2"></td> <td colspan="6"></td> <td>Cycle Length: 147</td> </tr> <tr> <th colspan="2">Action:</th> <td colspan="2">9</td> <td colspan="2"></td> <td colspan="2"></td> <td colspan="6"></td> <td></td> </tr> <tr> <th colspan="2">Times of Operation:</th> <td colspan="4">Mon. - Fri.:</td> <td colspan="4">Sat.:</td> <td colspan="4">Sun.:</td> <td></td> </tr> </thead> </table>														Hurricane Evacuation														Int. Times		117	4	1	10	4	1	5	4	1				Signal Heads	Phasing		Φ2 + Φ6		Φ4 + Φ8		Φ1 + Φ5									Split	sec	85	85	15	15	10	10								Coord Φ:		Φ6												Offset = 5 sec	Max:															MAX INHIBIT															Pattern/Split:		9												Cycle Length: 147	Action:		9													Times of Operation:		Mon. - Fri.:				Sat.:				Sun.:											
Hurricane Evacuation																																																																																																																																																																									
Int. Times		117	4	1	10	4	1	5	4	1				Signal Heads																																																																																																																																																											
Phasing		Φ2 + Φ6		Φ4 + Φ8		Φ1 + Φ5																																																																																																																																																																			
Split	sec	85	85	15	15	10	10																																																																																																																																																																		
Coord Φ:		Φ6												Offset = 5 sec																																																																																																																																																											
Max:																																																																																																																																																																									
MAX INHIBIT																																																																																																																																																																									
Pattern/Split:		9												Cycle Length: 147																																																																																																																																																											
Action:		9																																																																																																																																																																							
Times of Operation:		Mon. - Fri.:				Sat.:				Sun.:																																																																																																																																																															
Notes: 3 sec delay for Flashing Yellow Arrow																																																																																																																																																																									
Ring 1	Φ1	Turn	-	-	-									1																																																																																																																																																											
	Φ2	Thru	G	Y	R					<G	<G	<Y	<R	4,5,6																																																																																																																																																											
	Φ4	Turn				--	--	--						8																																																																																																																																																											
	Φ4	Thru				G	Y	R						7,8																																																																																																																																																											
PEDs																																																																																																																																																																									
Ring 2	Φ5	Turn	-	-	-					<G	<G	<Y	<R	6																																																																																																																																																											
	Φ6	Thru	G	Y	R					R	R	R		1,2,3																																																																																																																																																											
	Φ8	Turn				--	--	--						9																																																																																																																																																											
	Φ8	Thru				G	Y	R						9,10																																																																																																																																																											
PEDs																																																																																																																																																																									
OVERLAP																																																																																																																																																																									
<table border="1"> <thead> <tr> <th colspan="14">Hurricane Evacuation</th> </tr> <tr> <th colspan="2">Int. Times</th> <td>117</td> <td>4</td> <td>1</td> <td>10</td> <td>4</td> <td>1</td> <td>5</td> <td>4</td> <td>1</td> <td colspan="3"></td> <td>Signal Heads</td> </tr> <tr> <th colspan="2">Phasing</th> <td colspan="2">Φ2 + Φ6</td> <td colspan="2">Φ4 + Φ8</td> <td colspan="2">Φ1 + Φ5</td> <td colspan="6"></td> <td></td> </tr> <tr> <th>Split</th> <th>sec</th> <td>85</td> <td>85</td> <td>15</td> <td>15</td> <td>10</td> <td>10</td> <td colspan="6"></td> <td>Offset = 7 sec</td> </tr> <tr> <th colspan="2">Coord Φ:</th> <td colspan="2">Φ2</td> <td colspan="2"></td> <td colspan="2"></td> <td colspan="6"></td> <td>Cycle Length: 90</td> </tr> <tr> <th colspan="2">Max:</th> <td colspan="12"></td> <td></td> </tr> <tr> <th colspan="2">MAX INHIBIT</th> <td colspan="12"></td> <td></td> </tr> <tr> <th colspan="2">Pattern/Split:</th> <td colspan="2">1</td> <td colspan="2"></td> <td colspan="2"></td> <td colspan="6"></td> <td></td> </tr> <tr> <th colspan="2">Action:</th> <td colspan="2">1</td> <td colspan="2"></td> <td colspan="2"></td> <td colspan="6"></td> <td></td> </tr> <tr> <th colspan="2">Times of Operation:</th> <td colspan="4">Mon. - Fri.:</td> <td colspan="4">15:00 - 18:00</td> <td colspan="4">Sat.:</td> <td colspan="2">Sun.:</td> </tr> </thead> </table>														Hurricane Evacuation														Int. Times		117	4	1	10	4	1	5	4	1				Signal Heads	Phasing		Φ2 + Φ6		Φ4 + Φ8		Φ1 + Φ5									Split	sec	85	85	15	15	10	10							Offset = 7 sec	Coord Φ:		Φ2												Cycle Length: 90	Max:															MAX INHIBIT															Pattern/Split:		1													Action:		1													Times of Operation:		Mon. - Fri.:				15:00 - 18:00				Sat.:				Sun.:							
Hurricane Evacuation																																																																																																																																																																									
Int. Times		117	4	1	10	4	1	5	4	1				Signal Heads																																																																																																																																																											
Phasing		Φ2 + Φ6		Φ4 + Φ8		Φ1 + Φ5																																																																																																																																																																			
Split	sec	85	85	15	15	10	10							Offset = 7 sec																																																																																																																																																											
Coord Φ:		Φ2												Cycle Length: 90																																																																																																																																																											
Max:																																																																																																																																																																									
MAX INHIBIT																																																																																																																																																																									
Pattern/Split:		1																																																																																																																																																																							
Action:		1																																																																																																																																																																							
Times of Operation:		Mon. - Fri.:				15:00 - 18:00				Sat.:				Sun.:																																																																																																																																																											
Notes: 3 sec delay for Flashing Yellow Arrow																																																																																																																																																																									
Ring 1	Φ1	Turn	<FY	<FY	<SY	<R								1																																																																																																																																																											
	Φ2	Thru	G	G	Y	R				<G	<G	<SY	<R	4,5,6																																																																																																																																																											
	Φ4	Turn				--	--	--						8																																																																																																																																																											
	Φ4	Thru				G	Y	R						7,8																																																																																																																																																											
PEDs																																																																																																																																																																									
Ring 2	Φ5	Turn	<FY	<FY	<SY	<R								6																																																																																																																																																											
	Φ6	Thru	G	G	Y	R				<G	<G	<SY	<R	1,2,3																																																																																																																																																											
	Φ8	Turn				--	--	--						9																																																																																																																																																											
	Φ8	Thru				G	Y	R						9,10																																																																																																																																																											
PEDs																																																																																																																																																																									
OVERLAP																																																																																																																																																																									
<table border="1"> <thead> <tr> <th colspan="14">Hurricane Evacuation</th> </tr> <tr> <th colspan="2">Int. Times</th> <td>18</td> <td>12</td> <td>4</td> <td>1</td> <td>8</td> <td>7</td> <td>4</td> <td>1</td> <td>5</td> <td>5</td> <td>4</td> <td>1</td> <td>3</td> <td>2</td> <td>4</td> <td>1</td> <td>Signal Heads</td> </tr> <tr> <th colspan="2">Phasing</th> <td colspan="2">Φ2 + Φ6</td> <td colspan="2">Φ4</td> <td colspan="2">Φ8</td> <td colspan="2">Φ1 + Φ5</td> <td colspan="6"></td> <td></td> </tr> <tr> <th>Split</th> <th>sec</th> <td>35</td> <td>35</td> <td>15</td> <td>15</td> <td>10</td> <td>10</td> <td colspan="6"></td> <td>Offset = 14 sec</td> </tr> <tr> <th colspan="2">Coord Φ:</th> <td colspan="2">Φ6</td> <td colspan="2"></td> <td colspan="2"></td> <td colspan="6"></td> <td>Cycle Length: 80</td> </tr> <tr> <th colspan="2">Max:</th> <td colspan="12"></td> <td></td> </tr> <tr> <th colspan="2">MAX INHIBIT</th> <td colspan="12"></td> <td></td> </tr> <tr> <th colspan="2">Pattern/Split:</th> <td colspan="2">2</td> <td colspan="2"></td> <td colspan="2"></td> <td colspan="6"></td> <td></td> </tr> <tr> <th colspan="2">Action:</th> <td colspan="2">2</td> <td colspan="2"></td> <td colspan="2"></td> <td colspan="6"></td> <td></td> </tr> <tr> <th colspan="2">Times of Operation:</th> <td colspan="4">Mon. - Fri.:</td> <td colspan="4">06:00 - 09:00</td> <td colspan="4">Sat.:</td> <td colspan="2">Sun.:</td> </tr> </thead> </table>														Hurricane Evacuation														Int. Times		18	12	4	1	8	7	4	1	5	5	4	1	3	2	4	1	Signal Heads	Phasing		Φ2 + Φ6		Φ4		Φ8		Φ1 + Φ5									Split	sec	35	35	15	15	10	10							Offset = 14 sec	Coord Φ:		Φ6												Cycle Length: 80	Max:															MAX INHIBIT															Pattern/Split:		2													Action:		2													Times of Operation:		Mon. - Fri.:				06:00 - 09:00				Sat.:				Sun.:	
Hurricane Evacuation																																																																																																																																																																									
Int. Times		18	12	4	1	8	7	4	1	5	5	4	1	3	2	4	1	Signal Heads																																																																																																																																																							
Phasing		Φ2 + Φ6		Φ4		Φ8		Φ1 + Φ5																																																																																																																																																																	
Split	sec	35	35	15	15	10	10							Offset = 14 sec																																																																																																																																																											
Coord Φ:		Φ6												Cycle Length: 80																																																																																																																																																											
Max:																																																																																																																																																																									
MAX INHIBIT																																																																																																																																																																									
Pattern/Split:		2																																																																																																																																																																							
Action:		2																																																																																																																																																																							
Times of Operation:		Mon. - Fri.:				06:00 - 09:00				Sat.:				Sun.:																																																																																																																																																											
Notes: 3 sec delay for Flashing Yellow Arrow																																																																																																																																																																									

TRAFFIC SIGNAL INVENTORY (v3.2)												TSI NO. 88-343																																																																																																																																																															
LOUISIANA DEPARTMENT OF TRANSPORTATION AND DEVELOPMENT												PAGE 3 OF 8																																																																																																																																																															
INTERSECTION: LA 117 @ Cortana Rd.				CTRL SEC: 343-01		LOGMILE: 1.17																																																																																																																																																																					
CITY: Example-Ville		PARISH: Exaplana		LAT: 30.38792		LONG: -91.069035																																																																																																																																																																					
SIGNAL TYPE: Volume Density				INTERCONNECT TYPE: GPS & Fiber				REV. DATE:		INSTALL DATE																																																																																																																																																																	
SIGNAL WARRANTS:				MAINTAINED BY:				CONT. MANUF: Trafficware		SYS#:		Controller IP: 117.0.343.0																																																																																																																																																															
MAINTAINED BY: DOTD				COORDINATED WITH TSI #'S:				88-113, 88-117 & 88-340																																																																																																																																																																			
TRAFFIC SIGNAL COORDINATION PLANS (PHASING MAY VARY FROM FREE OPERATION)																																																																																																																																																																											
Ring 1	Φ1	Turn	--	--	--									1																																																																																																																																																													
	Φ2	Thru	G	G	G	G	G	G	Y	R				4,5,6																																																																																																																																																													
	Φ4	Turn				--	--	--	--					8																																																																																																																																																													
	Φ4	Thru				G	G	Y	R					7,8																																																																																																																																																													
PEDs																																																																																																																																																																											
Ring 2	Φ5	Turn	--	--	--					<G	<G	<Y		6																																																																																																																																																													
	Φ6	Thru	G	G	Y	R								1,2,3																																																																																																																																																													
	Φ8	Turn				--	--	--						9																																																																																																																																																													
	Φ8	Thru				G	G	Y	R					9,10																																																																																																																																																													
PEDs																																																																																																																																																																											
OVERLAP																																																																																																																																																																											
<table border="1"> <thead> <tr> <th colspan="14">Hurricane Evacuation</th> </tr> <tr> <th colspan="2">Int. Times</th> <td>24</td> <td>12</td> <td>4</td> <td>1</td> <td>5</td> <td>5</td> <td>4</td> <td>1</td> <td>10</td> <td>5</td> <td>4</td> <td>1</td> <td>3</td> <td>3</td> <td>4</td> <td>4</td> <td>Signal Heads</td> </tr> <tr> <th colspan="2">Phasing</th> <td colspan="2">Φ2 + Φ6</td> <td colspan="2">Φ2 + Φ5</td> <td colspan="2">Φ4 + Φ8</td> <td colspan="2">Φ1 + Φ6</td> <td colspan="6"></td> <td></td> </tr> <tr> <th>Split</th> <th>sec</th> <td>56</td> <td>55</td> <td>56</td> <td>15</td> <td>20</td> <td>20</td> <td>14</td> <td>55</td> <td colspan="6"></td> <td>Offset = 7 sec</td> </tr> <tr> <th colspan="2">Coord Φ:</th> <td colspan="2">Φ2</td> <td colspan="2"></td> <td colspan="2"></td> <td colspan="6"></td> <td>Cycle Length: 90</td> </tr> <tr> <th colspan="2">Max:</th> <td colspan="12"></td> <td></td> </tr> <tr> <th colspan="2">MAX INHIBIT</th> <td colspan="12"></td> <td></td> </tr> <tr> <th colspan="2">Pattern/Split:</th> <td colspan="2">1</td> <td colspan="2"></td> <td colspan="2"></td> <td colspan="6"></td> <td></td> </tr> <tr> <th colspan="2">Action:</th> <td colspan="2">1</td> <td colspan="2"></td> <td colspan="2"></td> <td colspan="6"></td> <td></td> </tr> <tr> <th colspan="2">Times of Operation:</th> <td colspan="4">Mon. - Fri.:</td> <td colspan="4">15:00 - 18:00</td> <td colspan="4">Sat.:</td> <td colspan="2">Sun.:</td> </tr> </thead> </table>														Hurricane Evacuation														Int. Times		24	12	4	1	5	5	4	1	10	5	4	1	3	3	4	4	Signal Heads	Phasing		Φ2 + Φ6		Φ2 + Φ5		Φ4 + Φ8		Φ1 + Φ6									Split	sec	56	55	56	15	20	20	14	55							Offset = 7 sec	Coord Φ:		Φ2												Cycle Length: 90	Max:															MAX INHIBIT															Pattern/Split:		1													Action:		1													Times of Operation:		Mon. - Fri.:				15:00 - 18:00				Sat.:				Sun.:	
Hurricane Evacuation																																																																																																																																																																											
Int. Times		24	12	4	1	5	5	4	1	10	5	4	1	3	3	4	4	Signal Heads																																																																																																																																																									
Phasing		Φ2 + Φ6		Φ2 + Φ5		Φ4 + Φ8		Φ1 + Φ6																																																																																																																																																																			
Split	sec	56	55	56	15	20	20	14	55							Offset = 7 sec																																																																																																																																																											
Coord Φ:		Φ2												Cycle Length: 90																																																																																																																																																													
Max:																																																																																																																																																																											
MAX INHIBIT																																																																																																																																																																											
Pattern/Split:		1																																																																																																																																																																									
Action:		1																																																																																																																																																																									
Times of Operation:		Mon. - Fri.:				15:00 - 18:00				Sat.:				Sun.:																																																																																																																																																													
Notes: 3 sec delay for Flashing Yellow Arrow																																																																																																																																																																											
Ring 1	Φ1	Turn	<FY	<FY	<SY	<R								1																																																																																																																																																													
	Φ2	Thru	G	G	Y	R				<G	<G	<SY	<R	4,5,6																																																																																																																																																													
	Φ4	Turn				--	--	--						8																																																																																																																																																													
	Φ4	Thru				G	Y	R						7,8																																																																																																																																																													
PEDs																																																																																																																																																																											
Ring 2	Φ5	Turn	<FY	<FY	<SY	<R								6																																																																																																																																																													
	Φ6	Thru	G	G	Y	R				<G	<G	<SY	<R	1,2,3																																																																																																																																																													
	Φ8	Turn				--	--	--						9																																																																																																																																																													
	Φ8	Thru				G	Y	R						9,10																																																																																																																																																													
PEDs																																																																																																																																																																											
OVERLAP																																																																																																																																																																											
<table border="1"> <thead> <tr> <th colspan="14">Hurricane Evacuation</th> </tr> <tr> <th colspan="2">Int. Times</th> <td>18</td> <td>12</td> <td>4</td> <td>1</td> <td>8</td> <td>7</td> <td>4</td> <td>1</td> <td>5</td> <td>5</td> <td>4</td> <td>1</td> <td>3</td> <td>2</td> <td>4</td> <td>1</td> <td>Signal Heads</td> </tr> <tr> <th colspan="2">Phasing</th> <td colspan="2">Φ2 + Φ6</td> <td colspan="2">Φ4</td> <td colspan="2">Φ8</td> <td colspan="2">Φ1 + Φ5</td> <td colspan="6"></td> <td></td> </tr> <tr> <th>Split</th> <th>sec</th> <td>35</td> <td>35</td> <td>15</td> <td>15</td> <td>10</td> <td>10</td> <td colspan="6"></td> <td>Offset = 14 sec</td> </tr> <tr> <th colspan="2">Coord Φ:</th> <td colspan="2">Φ6</td> <td colspan="2"></td> <td colspan="2"></td> <td colspan="6"></td> <td>Cycle Length: 80</td> </tr> <tr> <th colspan="2">Max:</th> <td colspan="12"></td> <td></td> </tr> <tr> <th colspan="2">MAX INHIBIT</th> <td colspan="12"></td> <td></td> </tr> <tr> <th colspan="2">Pattern/Split:</th> <td colspan="2">2</td> <td colspan="2"></td> <td colspan="2"></td> <td colspan="6"></td> <td></td> </tr> <tr> <th colspan="2">Action:</th> <td colspan="2">2</td> <td colspan="2"></td> <td colspan="2"></td> <td colspan="6"></td> <td></td> </tr> <tr> <th colspan="2">Times of Operation:</th> <td colspan="4">Mon. - Fri.:</td> <td colspan="4">06:00 - 09:00</td> <td colspan="4">Sat.:</td> <td colspan="2">Sun.:</td> </tr> </thead> </table>														Hurricane Evacuation														Int. Times		18	12	4	1	8	7	4	1	5	5	4	1	3	2	4	1	Signal Heads	Phasing		Φ2 + Φ6		Φ4		Φ8		Φ1 + Φ5									Split	sec	35	35	15	15	10	10							Offset = 14 sec	Coord Φ:		Φ6												Cycle Length: 80	Max:															MAX INHIBIT															Pattern/Split:		2													Action:		2													Times of Operation:		Mon. - Fri.:				06:00 - 09:00				Sat.:				Sun.:			
Hurricane Evacuation																																																																																																																																																																											
Int. Times		18	12	4	1	8	7	4	1	5	5	4	1	3	2	4	1	Signal Heads																																																																																																																																																									
Phasing		Φ2 + Φ6		Φ4		Φ8		Φ1 + Φ5																																																																																																																																																																			
Split	sec	35	35	15	15	10	10							Offset = 14 sec																																																																																																																																																													
Coord Φ:		Φ6												Cycle Length: 80																																																																																																																																																													
Max:																																																																																																																																																																											
MAX INHIBIT																																																																																																																																																																											
Pattern/Split:		2																																																																																																																																																																									
Action:		2																																																																																																																																																																									
Times of Operation:		Mon. - Fri.:				06:00 - 09:00				Sat.:				Sun.:																																																																																																																																																													
Notes: 3 sec delay for Flashing Yellow Arrow																																																																																																																																																																											

SHEET NUMBER	27
DISTRICT	91
FEDERAL PROJECT	H117343
STATE PROJECT	H.117343
DESIGNED	H. QUINN
CHECKED	E. NIGMA
DATE	7/01/2020
REVISION DESCRIPTION	
NO.	
DATE	
BY	
TSI # 88-343 LA 117 @ CORTANA RD. LA 117 INTERSECTION UPGRADES	
DOTD DOTD TRAFFIC ENGINEERING	

EXAMPLE PLANS

EXAMPLE PLANS

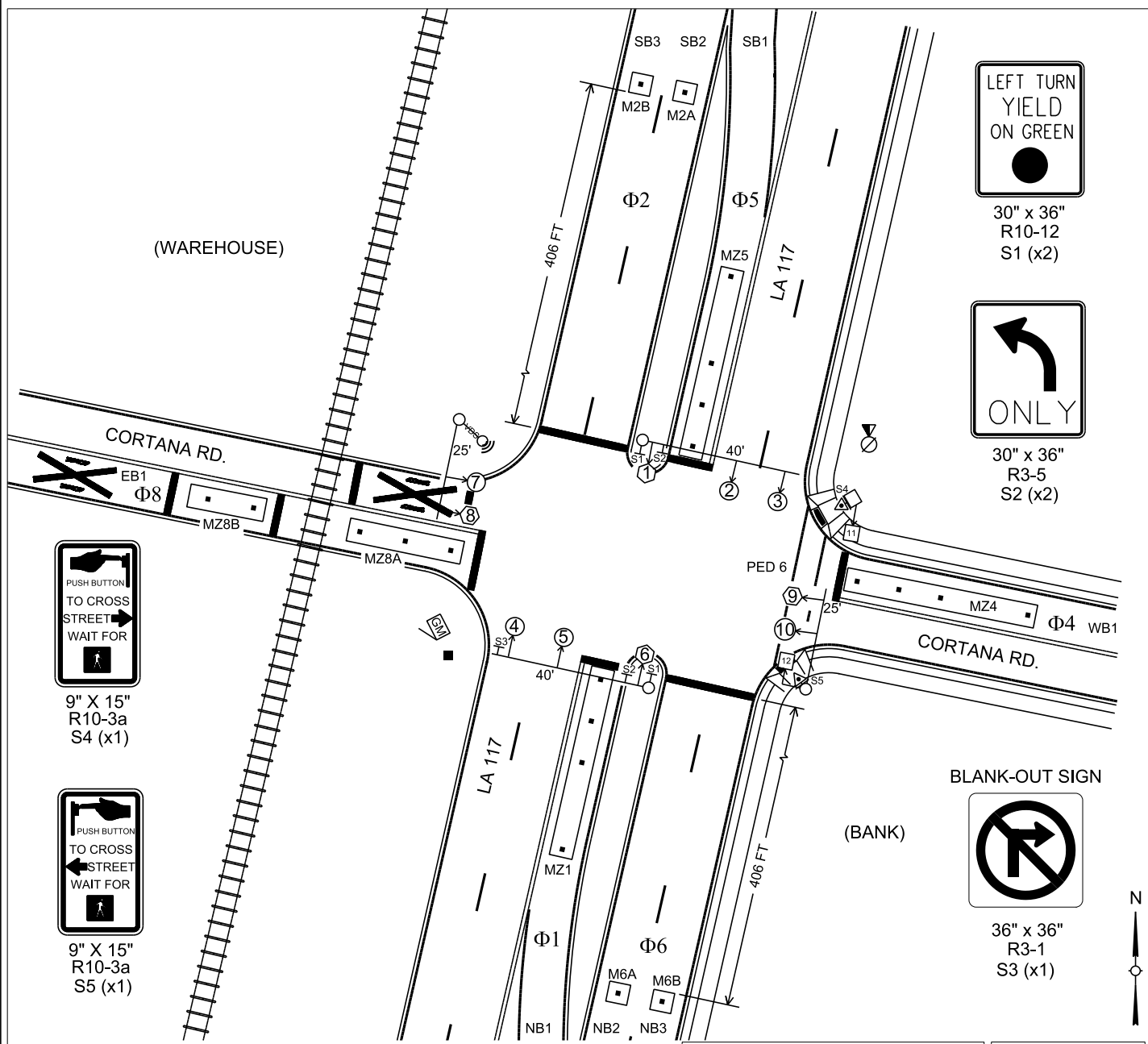

BACKPLATES: YES NO SIGNAL HEAD HEIGHT: 19 FT
 INTERSECTION: LA 117 @ CORTANA RD. TSI #: 88-343 PAGE 5 OF 8

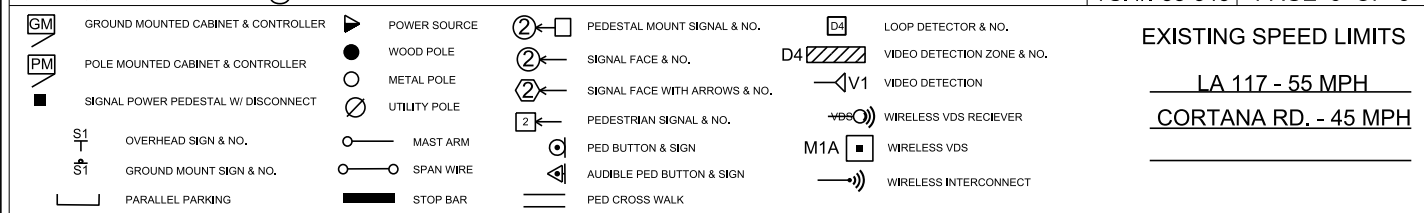

EXISTING SPEED LIMITS
 LA 117 - 55 MPH
 CORTANA RD. - 45 MPH

SIGNAL FACES	2,3,4, 5,7,10	8,9	1,6	11,12
TOTALS	6	2	2	2
DK = DARK				
R = RED	(R)	(R)	(R)	(R)
Y = YELLOW	(Y)	(Y)	(Y)	(Y)
G = GREEN	(G)	(G)	(G)	(G)
↔ = GREEN ARROW	(↔)	(↔)	(↔)	(↔)
↔ = YELLOW ARROW	(↔)	(↔)	(↔)	(↔)
↔ = STEADY YELLOW ARROW	(↔)	(↔)	(↔)	(↔)
↔ = FLASHING YELLOW ARROW	(↔)	(↔)	(↔)	(↔)
8" = 8" DIA. LENS				
12" = 12" DIA. LENS				
OP = OPTICALLY PROGRAMMED LENS				

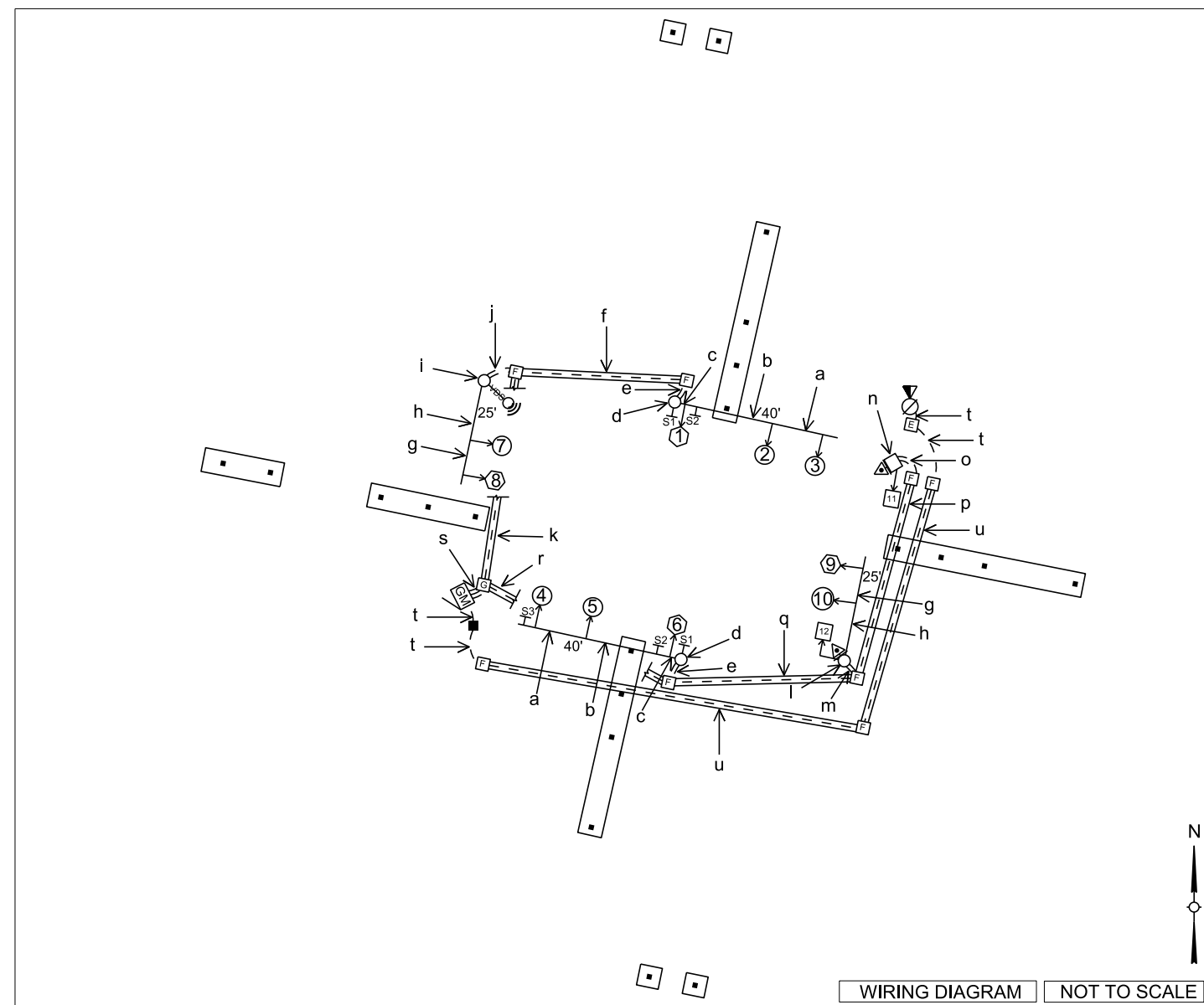

INTERSECTION: LA 117 @ CORTANA RD. TSI #: 88-343 PAGE 6 OF 8

WIRING CODE TABLE

WIRING CODE	WIRING TYPE										INTERCONNECT			CONDUIT		TYPE	
	VIDEO	LOOP	2CLL	2C	MAG	3C	POWER	3C	6C	10C	7C	Wireless	6 PAIR	FIBER	NO.		SIZE
a										1							OH
b										2							OH
c										2	1						OH
d										2	1						IP
e										2							TB
f										2							JB
g										1							OH
h										1							OH
i						1				1	1						IP
j						1				1	1						TB
k						1				1	3						JB
l						1				2	1						IP
m						1				2	1						TB
n						1				1							IP
o						1				1							TB
p						1				1							JB
q						2				3	1						JB
r						2				3	3						JB
s						2	1			4	6						TB
t										1							TB
u										1							JB

OH - OVERHEAD JB - JACK OR BORE TB - TRENCH AND BACKFILL SC - SAW CUT IP - INSIDE POLE
 WIRING CODE TABLE VERSION 3.2

SHEET NUMBER	28
DISTRICT	DISTRICT 91
FEDERAL PROJECT	H117343
STATE PROJECT	H.117343
DESIGNED	H. QUINN
CHECKED	E. NIGMA
DATE	7/01/2020
BY	3 of 5
REVISION DESCRIPTION	
DATE	
NO.	
TSI # 88-343 LA 117 @ CORTANA RD. LA 117 INTERSECTION UPGRADES	
DOTD TRAFFIC ENGINEERING	

T:\Traffic Signals\Traffic Signal Manual\Example TSI 3-2\FYA-Intersection_V3-2\004_88-343_TSI_CountsAndNotesV3-1.dgn 6/29/2020 12:4

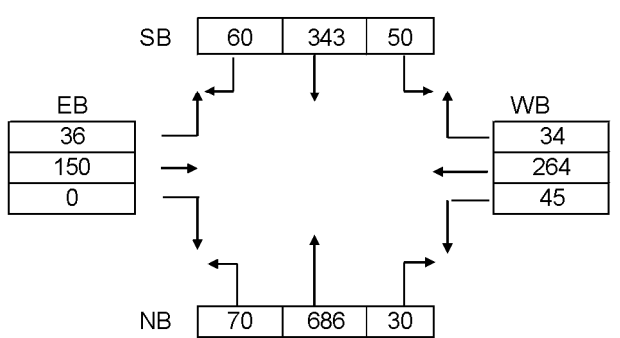
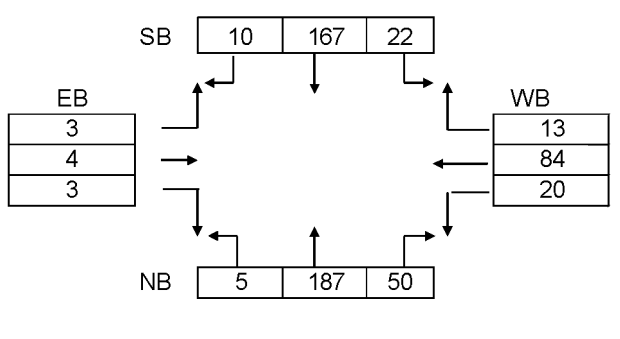
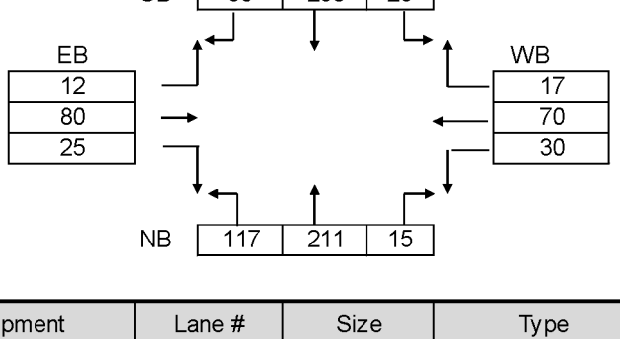
TRAFFIC SIGNAL INVENTORY (v3.2)						TSI NO. 88-343	
LOUISIANA DEPARTMENT OF TRANSPORTATION AND DEVELOPMENT						PAGE: 7 OF 8	
<p>Intersection: LA 117 @ Cortana Rd.</p> <p style="text-align: center;">TRAFFIC VOLUMES -</p> <p>AM PEAK HOUR: 7:00:00 AM to 8:00:00 AM</p> <p>Count Date: 1/17/2020 PHF: 0.94</p>  <p>MIDDAY PEAK HOUR: ##### to 1:00:00 PM</p> <p>Count Date: 1/17/2020 PHF: 0.94</p>  <p>PM PEAK HOUR: 4:00:00 PM to 5:00:00 PM</p> <p>Count Date: 1/17/2020 PHF: 0.92</p> 							
Detector #	Delay(s)	Extends(s)	Phase	Equipment	Lane #	Size	Type
MZ1			Φ1	Magnetometer	NB1	1-6x50	Stopbar
M2A			Φ2	Magnetometer	SB2	1-6x6	Setback
M2B			Φ2	Magnetometer	SB3	1-6x6	Setback
MZ4	3		Φ4	Magnetometer	WB1	1-6x50	Stopbar
M6A			Φ6	Magnetometer	NB2	1-6x6	Setback
M6B			Φ6	Magnetometer	NB3	1-6x6	Setback
MZ8A	3		Φ8	Magnetometer	EB1	1-6x30	Stopbar
MZ8B			Φ8	Magnetometer	EB1	1-6x20	Stopbar

- 1) CONTRACTOR SHALL CONTACT SECTION 45 SIGNAL INSPECTORS AND SCHEDULE A BENCH TEST FOR THE FULLY FUNCTIONAL CABINET INCLUDING CONTROLLER AND MMU UNIT, AT THE SECTION 45 SIGNAL SHOP (7868 TOM DRIVE, BATON ROUGE 70806) A MINIMUM OF 7 DAYS BEFORE SIGNAL ACTIVATION. APPROVED TSI PLAN SHALL BE PROVIDED IN THE SIGNAL CABINET. AT LEAST ONE TECHNICAL CONTRACTOR REP MAY BE REQUIRED TO BE PRESENT FOR THE BENCH TESTING.
- 2) A MINIMUM OF ONE PERSON WITH A LEVEL I IMSA CERTIFICATION IS REQUIRED ON SITE AT ALL TIMES FOR ALL WORK OUTSIDE OF A TRAFFIC SIGNAL CABINET.
- 3) A LEVEL II IMSA CERTIFICATION IS REQUIRED FOR ALL WORK INSIDE A TRAFFIC SIGNAL CABINET.
- 4) CONTRACTOR TO PROVIDE CERTIFIED 980 ATC CONTROLLER.
SEE CERTIFICATION:
http://wwwsp.dotd.la.gov/Inside_LaDOTD/Divisions/Engineering/Traffic_Engineering/Traffic%20Control/Traffic%20Signal%20Controller%20Certification%202016.pdf
- 5) FLASHING YELLOW ARROW (FYA) SHALL HAVE A 3 SECOND DELAY.
- 6) SEE TRAFFIC SIGNAL STANDARD PLANS (SHEETS 300-314) FOR TERMINAL WIRING CONNECTIONS.

SPEC	NUMBER	DESCRIPTION	UNITS	88-343
729-01-	00100	Sign (Type A)	SF	31.875
736-01-	00100	Trenching and Backfilling	LF	170
736-03-	00100	Jacking or Boring for Conduit	LF	420
736-04-	00001	Signal Pole (Pedestal Pole)	Ea	1
736-04-	10250	Signal Pole (Single Mast Arm, 25ft)	Ea	2
736-04-	10400	Signal Pole (Single Mast Arm, 40ft)	Ea	2
736-05-	30000	Signal Heads (3 Section, 12 inch Led Lens, R, Y, G)	Ea	6
736-05-	41000	Signal Heads (4 Section, 12 inch Led Lens, R, Y, LT, G, G)	Ea	2
736-05-	41200	Signal Heads (4 Section, 12 inch Led Lens, LT, R, LT, Y, FLT, Y, LT, G)	Ea	2
736-06-	00100	Signal Service	Ea	1
736-06-	00500	Signal Service Pedestal Disconnect	Ea	1
736-08-	00102	Signal Controller (980 ATC, Type 2)(Fumish & Install)	Ea	1
736-10-	00200	Underground Junction Box (Type E)	Ea	1
736-10-	00300	Underground Junction Box (Type F)	Ea	8
736-10-	00400	Underground Junction Box (Type G)	Ea	1
736-11-	00200	Conduit (2" HDPE, Schedule 80)	LF	50
736-11-	00300	Conduit (3" HDPE, Schedule 80)	LF	680
736-12-	02014	Conductor (2c, #14 awg)	LF	375
736-12-	03006	Conductor (3c, 6 gauge / #6 awg)	LF	210
736-12-	06014	Conductor (6c, #14 awg)	LF	900
736-12-	10014	Conductor (10c, #14 awg)	LF	850
736-15-	02400	Signal Support (Foundation, 24 inch Minimum Diameter)	Ea	1
736-15-	03600	Signal Support (Foundation, 36 inch Minimum Diameter)	Ea	4
736-22-	00000	Pedestrian Push Button	Ea	2
736-23-	00000	LED Blank Out Sign	Ea	1
NS-736-	00001	GPS	Ea	1
NS-736-	00020	Wireless Magnetometer Vehicle Detection System (Cabinet Components)	Ea	1
NS-736-	00021	Wireless Magnetometer Vehicle Detection System (Antennas)	Ea	1
NS-736-	00022	Wireless Magnetometer Vehicle Detection System (Magnetometers)	Ea	21
NS-736-	00130	TS-2 Traffic Signal Cabinet (Ground Mounted)	Ea	1
NS-736-	00135	2-Wire Accessible Pedestrian Pushbutton Detectors	Ea	2
NS-736-	00136	2-Wire Accessible Pedestrian Pushbutton Cabinet Control	Ea	1
NS-ITS-	04035	Fiber Optic Fan Out Kits, SM, 12 Strand, Fumish & Install	Ea	1
NS-ITS-	04180	Fiber Optic Connection, Install, Splice	Ea	4
NS-ITS-	04200	Fiber Optic Connection, Termination, Fumish & Install	Ea	4
NS-ITS-	04250	Fiber Optic Drop Cable, SM, 12 Strand, Fumish & Install	LF	200
NS-ITS-	04290	Fiber Optic Patch Cord, SM, 2 Strand, Fumish & Install	Ea	2
NS-ITS-	04425	Fiber Optic Connection Patch Panel, Outdoor, Fumish & Install	Ea	1
NS-ITS-	09080	Local Ethernet Switch, Fumish & Install	Ea	1

SHEET NUMBER	29	DISTRICT	91	FEDERAL PROJECT	H 117343	STATE PROJECT	H 117343
DESIGNED	H. QUINN	CHECKED	E. NIGMA	DATE	7/01/2020	SHEET	4 of 5
REVISION	DESCRIPTION	NO.	DATE	BY			
TSI # 88-343 LA 117 @ CORTANA RD. LA 117 INTERSECTION UPGRADES							

EXAMPLE PLANS

EXAMPLE PLANS



T:\Traffic Signals\Traffic Signal Manual\Example TSI 3-2\FYA-Intersection_V3-2\005_88-343_TSI_PreemptionAndExtraCoordsheetV3-1.dgn 6/29/2020 12:4

TRAFFIC SIGNAL INVENTORY (v3.2)

TSI NO. 88-343

LOUISIANA DEPARTMENT OF TRANSPORTATION AND DEVELOPMENT

PAGE: 8 OF 8

INTERSECTION: LA 117 @ Cortana Rd.

Railroad Preemption Sequence and Settings

Min Green	Cord thru Pre-empt
1	YES

Track Clearance		
G	Y	R
20	4	1

Dwell Phases

Exit Phase		
G	Y	R
10	4	1

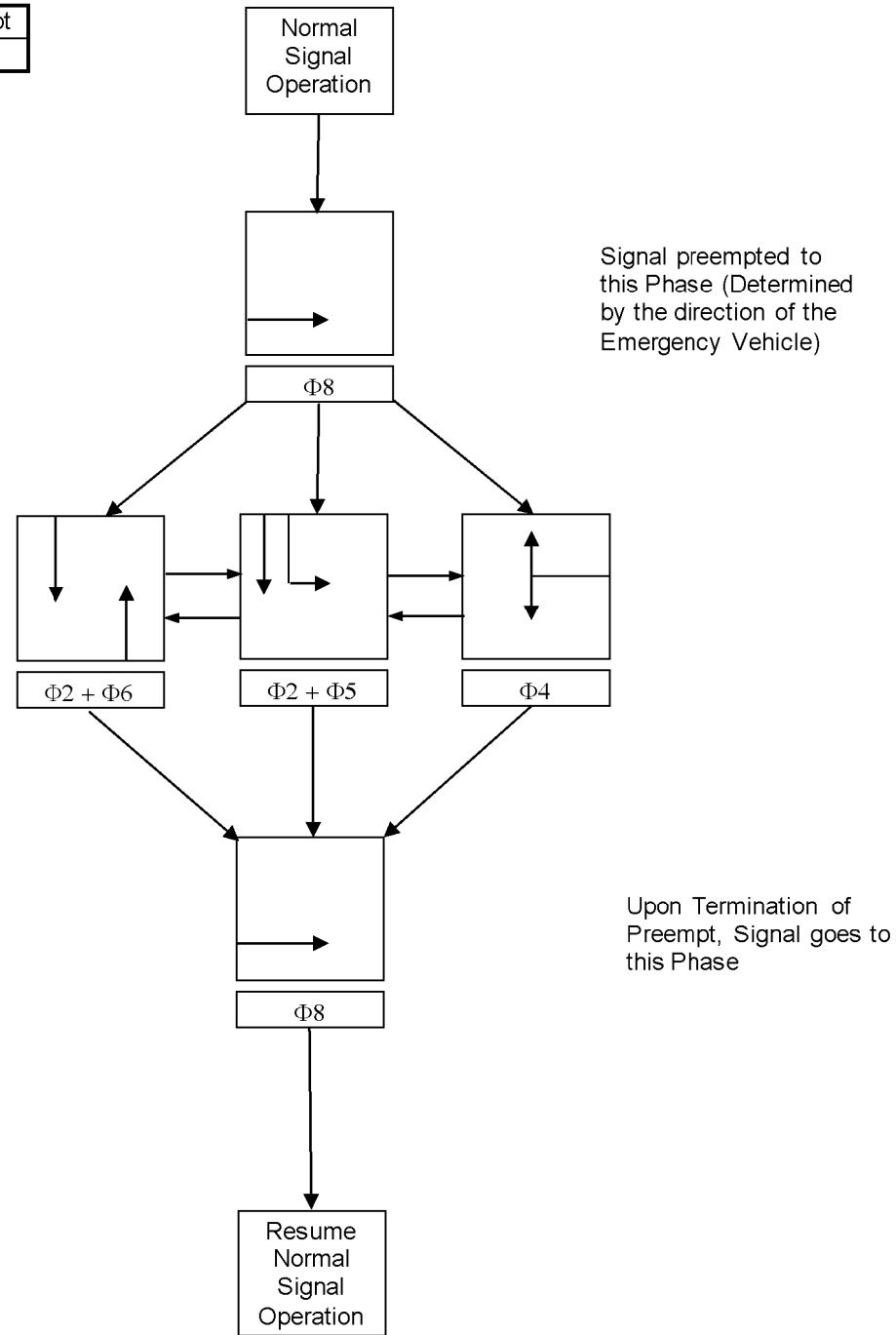

Signal preempted to this Phase (Determined by the direction of the Emergency Vehicle)

Upon Termination of Preempt, Signal goes to this Phase

Signal in this Phase when preemption occurs

SHEET NUMBER	30
DISTRICT	DISTRICT 91
FEDERAL PROJECT	H117343
STATE PROJECT	H.117343
DESIGNED	H. QUINN
CHECKED	E. NIGMA
DETAILED	H. QUINN
CHECKED	E. NIGMA
DATE	7/01/2020
SHEET	5 of 5
NO.	DATE
BY	REVISION DESCRIPTION
TSI # 88-343 LA 117 @ CORTANA RD. LA 117 INTERSECTION UPGRADES	

